



# AV & Media

## Price Guide 2023

All prices exc. VAT    Valid from 03/04/2023

# Contents

## ABOUT US **1**

Who are we?	1
FREE Space Planning + Consultation Service	5
Customisation	5
Branding	7

## AUDIO VISUAL LECTERNS **9**

Gemini (Height Adjustable)	11
Gemini (Fixed Height)	13
Aries	15
Contour	17
Expert	19
Bravo HA	21
Starlite	22
Explorer	24
Credenza	25
Rubi	26
Messenger	27
Messenger Mobile	28
Juno	29
Slimline Active Learning Console	30
/ Slimline Active Learning Bar	30
Cable Raceway	31
Writing Capture Surfaces	32
Desktop Machining	33
Lectern Accessories	35
Neptune Rack Cabinet	37
Neptune Accessories	38

## COLLABORATIVE TABLES **39**

Synergy Fusion	41
Synergy Atmos	42
Synergy Quad	43
Synergy Blade	45
Synergy Teardrop	47
Synergy Plectrum	48
Synergy Reverse Plectrum	49
Synergy HA	50
Synergy 'Sit-Stand'	51
Synergy Folding	52
Data Interface Plates	53
Unity	55
Focus Pod	57
Collaborative Table Accessories	59

## SCREEN TROLLEYS & STANDS **61**

Rise	63
Rise + Arc	64
CoACT	65
Switch 90	66
Spire Trolley	67
Spire	68
Adapt	69
Adapt HA	70
Levigator HA	71
Discovery	72
Nova	73
DS Stand	74
AVI Tower	75
CVC Stand	76
Wayfinder	77
Wayfinder Mini	78

## SCREEN BRACKETS & MONITOR MOUNTS **79**

Monitor & Tablet Mounts	80
Screen Bracket Kits	81
Screen Brackets	81

## PROJECTOR MOUNTING SOLUTIONS **83**

Mounting Kits	83
Plates & Cages	84
Columns & Accessories	85
Ceiling Plates & Mounts	86

## COLOURS & FINISHES **87**

Colours & Finishes	89
Worktops & Edge Banding	90





### Price Guide Key:

**D** **Direct**  
Sold direct and also via resale channel

**RO** **Resale Only**  
Product sold exclusively via resale channel to all markets

**ROE** **Resale Only in Education**  
Product sold exclusively via resale channel into education markets

 Electrically Height Adjustable

 Manually Height Adjustable

 Removable Rack

### Affiliations:



Sustainable Furniture Solutions Agreement – Lot 3A  
Specialist IT/AV Integrated and/or Security Furniture  
[Rank 1 Supplier - Direct Award](#)

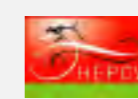

- ISO 9001:2015 for Quality Management
- ISO 14001:2015 for Environmental Management
- Contractors Health and Safety Assessment

- ISO 45001:2018 for Occupational Health and Safety Management systems Scheme
- Constructionline
- Cyber Essentials

# Experts in AV and IT Integrated Furniture Solutions

## Who are we?

TOP-TEC strongly believe that technology enhances learning and we develop specialist furniture solutions to enhance the use of AV and IT equipment. We aim to transform your spaces to support collaborative and active learning in today's education landscape.

### We pride ourselves on quality

With over 65 years of manufacturing experience, we pride ourselves on our quality and dependable solutions, and make all of our products at our factory in Birmingham.

### We consider IT and AV from the start, rather than as an afterthought

As a British company who design and manufacture in house, we are completely flexible and are always on hand to listen to our customer's challenges and tailor our products to help find a solution.

### A trusted partner to over 90% of the Universities in the UK

We believe in building long term relationships and always strive to create products that are built to last and provide value for money for our customers.

TOP-TEC is committed to enhancing learning through the use of technology. We do this by designing and manufacturing specialist furniture solutions that are tailored to integrate technology that aids in improving learning outcomes.



## Innovation is in our DNA...

Our in house design and manufacturing teams can tailor our solutions to meet your requirements in full, creating the right solution for you.

We listen to feedback and advice from our customers and design new products based on the challenges and demands of the education market.

Today, TOP-TEC is a market leader in AV & collaborative furniture in the education sector and we're only getting started!



### Keeping technology in its place...

Our range of Voyager lecterns were first on the market to feature an innovative side stop and back stop rack shelving system allowing users to secure their AV/IT equipment and still be able to use it with the door locked.



### Streamline your installation...

We were the first in the market to offer a removable racking system, allowing the rack to be populated at the integrators premises prior to the lectern being delivered, saving time during the installation process.

# | What's our story?

Established in 1957, we have a long history of developing innovative solutions and have earned a reputation for going above and beyond for our customers.



## Est. 1957

Founded as a steel fabricator, Amington Engineering specialising in industrial solutions.



Where it all began...



## 1980s

Started making TV stands for large global brands as sister company Dalen Limited.



Manufacturing TV stands



## 2000s

Started producing AV integrated and secure IT furniture solutions under our TOP-TEC brand, such as lecterns, collaborative furniture and secure workspace furnishing.



Our factory in Birmingham...



## Today

Market Leader of Audio Visual and Collaborative Furniture, supplied into over 90% of Universities in the UK and several international universities.



TOP-TEC

## How can we help?

Based in Birmingham, we employ over 70 people across our offices and factory.

We have built a reputation of going above and beyond the call of duty for our customers and always strive to give the best possible service.

With complete autonomy over the entire process from manufacture through to installation, we can operate as an extension of your team, building a relationship that runs throughout the whole product lifecycle.

## Installations around the globe...

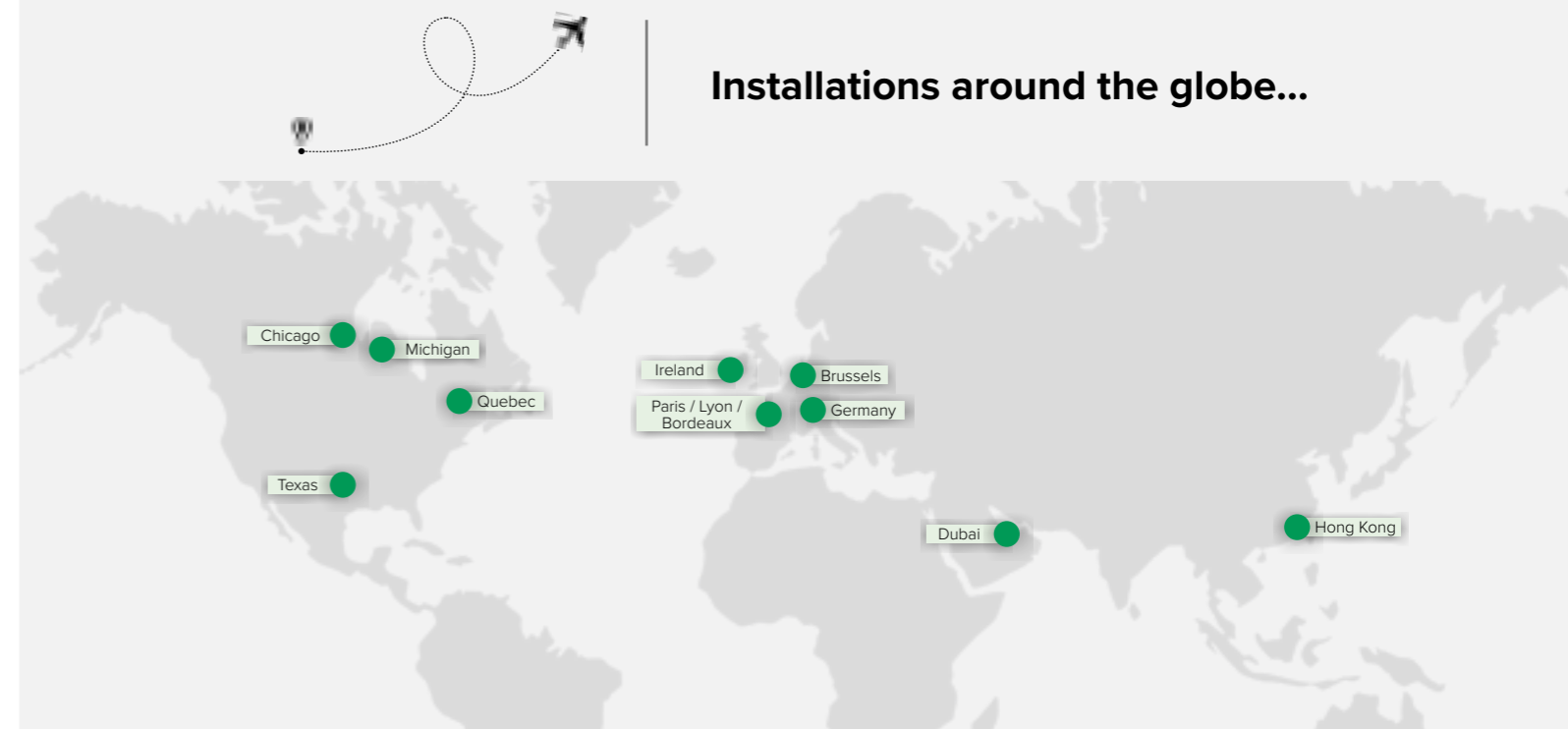

FREE

# space planning

+ consultation service

Our free room planning service enables us to provide you with visualisations of your spaces. We will then supply you with possible solutions for your consideration, including product designs and room-layouts **free of charge and without obligation.**

If you are looking to update existing rooms or have a brand-new learning environment that needs populating, let us do what we do best and help you maximise the potential of your space!

● 2D Drawings

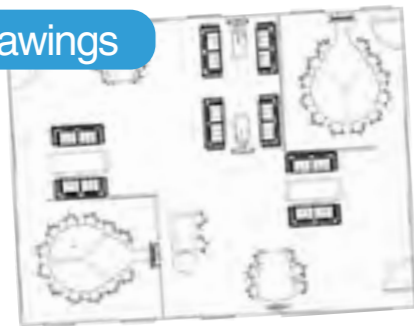

● 3D Renders

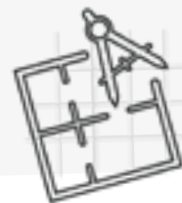
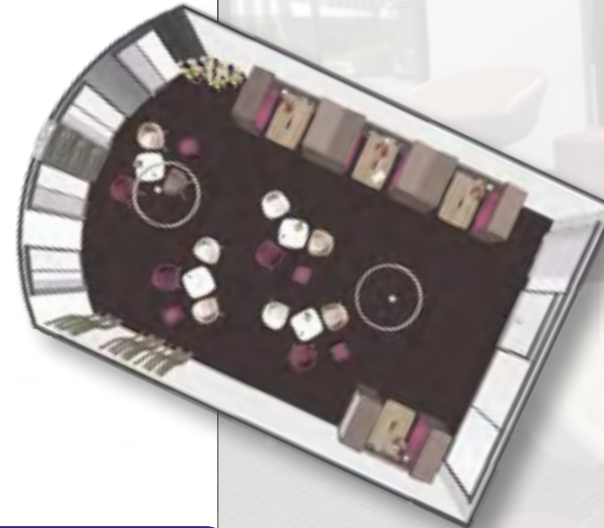

# customisation

As we design and manufacture all of our products in-house, we are able to provide a unique level of customisation to ensure that your requirements can be met in full.

This may include adapting our mounting equipment to fit your specific device, integrating your brand into our products, or configuring our furniture for your specific IT or AV needs.

If you have an unusual or non-standard requirement, call our advisers on **+44 (0)121 783 3838** and we will do our best to create a solution that fits your needs.

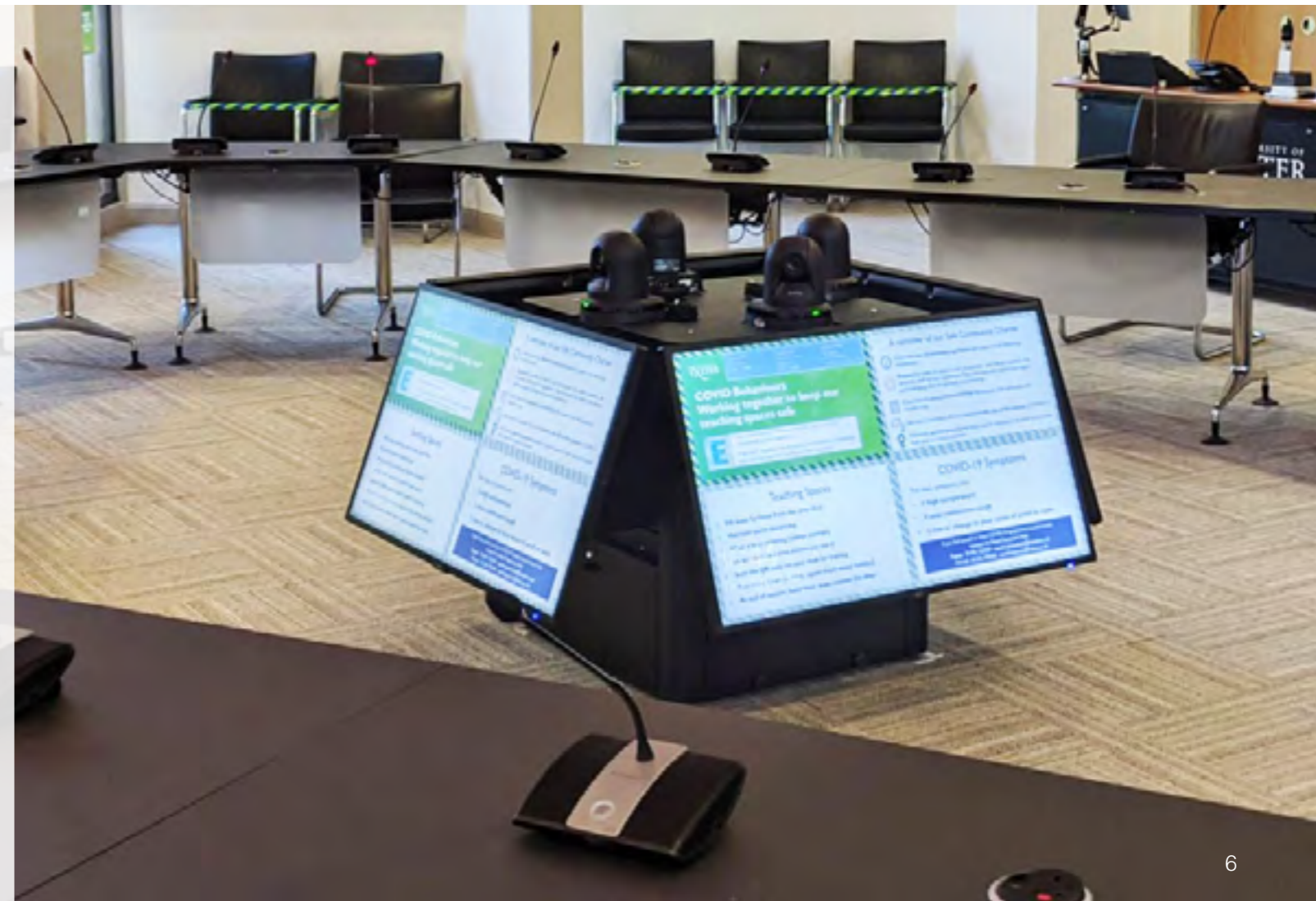

# Branding

## Illuminated Branding

A high-quality laser cut profile backed with an illuminated custom print of your logo so that we can achieve the design and style that you desire.

The location of the branding on each model of lectern is similar with the exact positioning determined by the size and design of the logo to ensure balance and harmony with the unit. Your customer service contact can provide further information and assistance if required.

### Included in the price:

- » ARIES                      » EXPERT                      » STARLITE
- » GEMINI                    » BRAVO HA
- » CONTOUR                » BRAVO DUET

CODE	DESCRIPTION	PRICE
VBRAND	Illuminated Branding	Included in above

### Optional extra on:

- » DS STAND                » CoACT

VBRAND	Illuminated Branding	£436
--------	----------------------	------

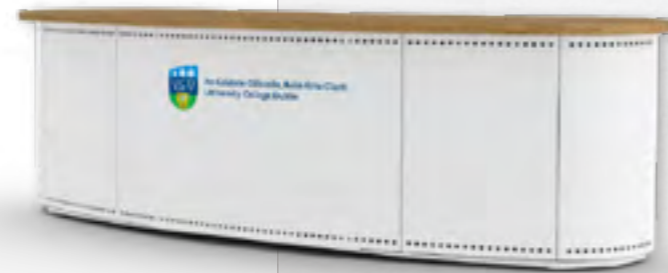

## Printed Branding

We can match your brand identity. High quality logos can be printed directly onto the surface of our products to promote your branding to customers, visitors and colleagues.

### Optional extra on:

- » MESSENGER            » RUBI                      » WAYFINDER MINI
- » EXPLORER             » JUNO                     » AVI TOWER
- » CREDENZA            » SALC                    » ADAPT

CODE	DESCRIPTION	PRICE
PBRAND	Printed Branding	£150

## Vinyl Branding

We still offer our vinyl branding service on some of our product ranges:

- » Screen Shrouds      » WAYFINDER

CODE	DESCRIPTION	PRICE
NBRAND	Vinyl Branding	£150
NWRAP	Vinyl Wrap	£578



# Audio Visual Lecterns

We provide a variety of lecterns as part of our Audio Visual furniture range. Our comprehensive range of AV lecterns are designed to complement all types of room, including small to medium sized teaching rooms, large lecture theatres, agile workspaces, presentation rooms and reception areas.



**Facilitates seamless AV/IT integration**  
Complete cable management creates an 'all-in-one' solution.



**Height adjustable**  
We offer a range of HA lecterns in which the entire surface rises and falls to match user preference.



**Removable rack**  
Allows rack to be populated at the integrators premises prior to the lectern being delivered.



**Secure your AV equipment**  
Robust steel construction and drill resistant locks provide a high level of security.



**Make it your own!**  
Choose from a wide range of accessories and finishes.



**Rack Shelves**  
Rack shelves are no longer supplied as standard, as our feedback is that many customers do not use them. They remain available FOC on request.



# GEMINI (Height Adjustable)



GEMINI is a range of electrically height adjustable desk style lecterns in which the entire surface rises and falls to meet the user's preference. Equality Act compliant, GEMINI also features easily accessible secure storage for both rack and non-rack mounted equipment, and is supplied with a versatile monitor arm. Its ergonomic design provides a spacious surface and is ideal for both seated and standing presentations in all room sizes.

GEMINI's modular design makes it easier to transport and install. GEMINI also comes with our innovative 19" removable rack system that allows the integrator to populate the lectern whilst the main unit is being configured, thus resulting in reduced lead times. GEMINI is supplied with illuminated branding as a standard feature.



Lectern accessories - pg 35

Rack shelves not included, please see pg 9.



Model	Solo (1250)		Mono (1400)		*Duet (1800)	
	12U	14U	12U	14U	12U	14U
Rack space						
Code	G4S12U-125	G4S14U-125	G4M12U-140	G4M14U-140	G4DT12U-180	G4DT14U-180
Price	£5,514	£5,664	£7,046	£7,197	£9,093	£9,394

## INCLUDED

	Solo (1250)	Mono (1400)	*Duet (1800)
Choice of standard paint & worktop finishes	pg 89	pg 89	pg 89
Half U's open in door (std)	✓	✓	✓
Left or right hand	X	✓	X
Illuminated branding (vinyl or printed on request)	✓	✓	✓
Monitor arm (ENDO72 or 82)	✓	✓	✓

## ADDITIONAL COST (See all accessories on pg 35)

	Solo (1250)	Mono (1400)	*Duet (1800)
Non-standard paint & worktop finishes	pg 89	pg 89	pg 89
Writing surface inlay	pg 32	pg 32	pg 32
Desktop machining	pg 33	pg 33	pg 33
Castors (GCUX)	x4	x6	x8

## MEASUREMENTS

	Solo (1250)	Mono (1400)	*Duet (1800)
Width (mm)	1250	1400	1800
Depth (mm)	800	800	800
Height - HA (mm)	800 - 1150   890 - 1240	740 - 1080   850 - 1190	740 - 1080   850 - 1190
Weight (kg)	130	162	200

\*Please note: Gemini 1800 Duet has a gap between the racks of 593mm and as a result may not be suitable for all wheelchair users.

Model	Mono (2200)		Duet (2200)		Mono (3000)		Duet (3000)	
	12U	14U	12U	14U	12U	14U	12U	14U
Rack space								
Code	G4M12U-220	G4M14U-220	G4DT12U-220	G4DT14U-220	G4M12U-300	G4M14U-300	G4DT12U-300	G4DT14U-300
Price	£8,243	£8,385	£9,178	£9,480	£9,449	£9,600	£9,937	£10,350

## INCLUDED

	Mono (2200)	Duet (2200)	Mono (3000)	Duet (3000)
Choice of standard paint & worktop finishes	pg 89	pg 89	pg 89	pg 89
Half U's open in door (std)	✓	✓	✓	✓
Left or right hand	✓	X	✓	X
Illuminated branding (vinyl or printed on request)	✓	✓	✓	✓
Monitor arm (ENDO72 or 82)	✓	✓	✓	✓

## ADDITIONAL COST (See all accessories on pg 35)

	Mono (2200)	Duet (2200)	Mono (3000)	Duet (3000)
Non-standard paint & worktop finishes	pg 89	pg 89	pg 89	pg 89
Writing surface inlay	pg 32	pg 32	pg 32	pg 32
Desktop machining	pg 33	pg 33	pg 33	pg 33
Castors (GCUX)	x6	x8	x6	x8

## MEASUREMENTS

	Mono (2200)	Duet (2200)	Mono (3000)	Duet (3000)
Width (mm)	2200	2200	3000	3000
Depth (mm)	800	800	800	800
Height - HA (mm)	740 - 1080   850 - 1190	740 - 1080   850 - 1190	740 - 1080   850 - 1190	740 - 1080   850 - 1190
Weight (kg)	231	266	301	339



# GEMINI (Fixed Height)

We also offer a range of fixed height models if you are looking to incorporate the Gemini style into your space without the need for height adjustment.

Fixed height models still feature all the best bits from our height adjustable models including illuminate branding, 19" removable racking system and extensive rack access (please see previous page).



Lectern accessories - pg 35

Rack shelves not included, please see pg 9.



Model	Solo (1250)		Mono (1400)		*Duet (1800)	
	12U	14U	12U	14U	12U	14U
Rack space						
Code	G4SF12U-125	G4SF14U-125	G4MF12U-140	G4MF14U-140	G4DTF12U-180	G4DTF14U-180
Price	£3,381	£3,531	£4,285	£4,432	£6,894	£7,197

### INCLUDED

	Solo (1250)	Mono (1400)	*Duet (1800)
Choice of standard paint & worktop finishes	pg 89	pg 89	pg 89
Half U's open in door (std)	✓	✓	✓
Left or right hand	X	✓	X
Illuminated branding (vinyl or printed on request)	✓	✓	✓
Monitor arm (ENDO72 or 82)	✓	✓	✓

### ADDITIONAL COST (See all accessories on pg 35)

	Solo (1250)	Mono (1400)	*Duet (1800)
Non-standard paint & worktop finishes	pg 89	pg 89	pg 89
Writing surface inlay	pg 32	pg 32	pg 32
Desktop machining	pg 33	pg 33	pg 33
Castors (GCUX)	x4	x6	x8

### MEASUREMENTS

	Solo (1250)		Mono (1400)		*Duet (1800)	
Width (mm)	1250		1400		1800	
Depth (mm)	800		800		800	
Height (mm)	694	783	694	783	694	783
Weight (kg)	130		162		200	

● Please note: Gemini 1800 Duet has a gap between the racks of 593mm and as a result may not be suitable for all wheelchair users.

Model	Mono (2200)		Duet (2200)		Mono (3000)		Duet (3000)	
	12U	14U	12U	14U	12U	14U	12U	14U
Rack space								
Code	G4MF12U-220	G4MF14U-220	G4DTF12U-220	G4DTF14U-220	G4MF12U-300	G4MF14U-300	G4DTF12U-300	G4DTF14U-300
Price	£4,453	£4,604	£7,476	£7,779	£8,234	£8,385	£9,249	£9,552

### INCLUDED

	Mono (2200)	Duet (2200)	Mono (3000)	Duet (3000)
Choice of standard paint & worktop finishes	pg 89	pg 89	pg 89	pg 89
Half U's open in door (std)	✓	✓	✓	✓
Left or right hand	✓	X	✓	X
Illuminated branding (vinyl or printed on request)	✓	✓	✓	✓
Monitor arm (ENDO72 or 82)	✓	✓	✓	✓

### ADDITIONAL COST (See all accessories on pg 35)

	Mono (2200)	Duet (2200)	Mono (3000)	Duet (3000)
Non-standard paint & worktop finishes	pg 89	pg 89	pg 89	pg 89
Writing surface inlay	pg 32	pg 32	pg 32	pg 32
Desktop machining	pg 33	pg 33	pg 33	pg 33
Castors (GCUX)	x6	x8	x6	x8

### MEASUREMENTS

	Mono (2200)		Duet (2200)		Mono (3000)		Duet (3000)	
Width (mm)	2200		2200		3000		3000	
Depth (mm)	800		800		800		800	
Height (mm)	694	783	694	783	694	783	694	783
Weight (kg)	231		266		301		339	

# ARIES

RO



ARIES is a stylish presentation lectern that features a height adjustable area that can be adjusted to suit your working angle or be fixed flat or angled at 15° (bespoke angles on request).

Equality Act compliant, ARIES incorporates 16U or 32U rack space, half the rack open as standard and our removable racking system that allows the integrator to pre-fit their AV/IT equipment prior to full installation.

With its ergonomic design and modular construction, ARIES also features internal cable management and an articulated monitor arm for an excellent user experience.

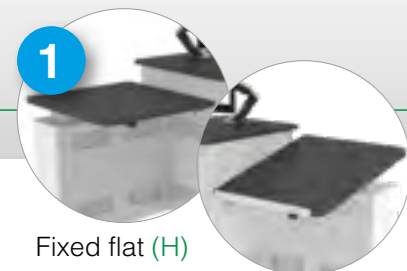

Fixed flat (H)



Fixed angled (15°) (A)

Lectern accessories - pg 35

Rack shelves not included, please see pg 9.

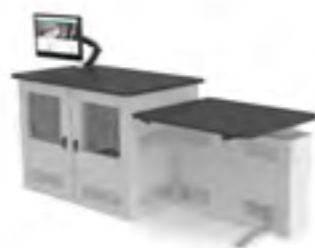

**Mono** (1400)

**Duo** (2200)

Code (see suffixes above)

A1MX

A1DX

Price

£7,065

£9,655

Rack space

16U

32U

**INCLUDED**

Choice of standard paint & worktop finishes	pg 89
Half U's open in door (std)	✓
Left or right hand	✓
Illuminated branding (vinyl or printed on request)	✓
Monitor arm (ENDO72 or 82)	✓

**ADDITIONAL COST** (See all accessories on pg 35)

Non-standard paint & worktop finishes	pg 89
Writing surface inlay	pg 32
Desktop machining	pg 33
Castors (GCUX)	x6

**MEASUREMENTS**

Width (mm)	1400	2200
Depth (mm)	800	800
Height (mm)	740	740
Height - HA panel (mm)	740 - 1080	740 - 1080
Weight (kg)	165	270



User adjustable working angle:



**Mono** (1400)

**Duo** (2200)

Code

A2M

A2D

Price

£7,065

£9,655

Rack space

16U

32U

**INCLUDED**

Choice of standard paint & worktop finishes	pg 89
Half U's open in door (std)	✓
Left or right hand	✓
Illuminated branding (vinyl or printed on request)	✓
Monitor arm (ENDO72 or 82)	✓

**ADDITIONAL COST** (See all accessories on pg 35)

Non-standard paint & worktop finishes	pg 89
Writing surface inlay	pg 32
Desktop machining	pg 33
Castors (GCUX)	x6

**MEASUREMENTS**

Width (mm)	1400	2200
Depth (mm)	800	800
Height (mm)	740	740
Height - HA panel (mm)	740 - 1080	740 - 1080
Weight (kg)	165	270

# CONTOUR



CONTOUR is a prestigious lectern, available in a large range of sizes to suit all room types. Designed to securely house media equipment, it is available with 16U or 32U rack space as standard, and 12U or 24U / 14U or 28U configurations on request.

CONTOUR is also supplied with a versatile monitor arm, illuminated branding and our innovative rack unit that allows non-rack mounted equipment to be secured within the rack space. The number of U's open on a door is customisable but standard configuration is for half the U's to be open and half closed.

The CONTOUR range features easy equipment access for maintenance, a large storage space, effective cable management and a removable rack system that allows media equipment to be installed at integrators premises while the lectern is still being built.



Lectern accessories - pg 35

Rack shelves not included, please see pg 9.

Rotating panel (Pico & Nano models only)



Model	<b>Solo</b> (1280)	<b>Pico</b> (1500)	<b>Nano</b> (1650)
Code	V4CS	V5CP	V5CN
Price	£5,106	£5,132	£5,293
Rack space	12U / 14U / 16U	12U / 14U / 16U	

### INCLUDED

Choice of standard paint & worktop finishes	pg 89	pg 89	
Half U's open in door (std)	✓	✓	
Left or right hand	✗	✓	
Illuminated branding (vinyl or printed on request)	✓	✓	
Monitor arm (ENDO72 or 82)	✓	✓	
Front & rear rack access	Removable panel	Rotating panel	

### ADDITIONAL COST (See all accessories on pg 35)

Non-standard paint & worktop finishes	pg 89	pg 89	
Writing surface inlay	pg 32	pg 32	
Desktop machining	pg 33	pg 33	
Castors	x4	x4	

### MEASUREMENTS

Width (mm)	1280	1500	1650
Depth (mm)	900	800	1030
Height (mm)	<b>12U:</b> 728 / <b>14U:</b> 799 / <b>16U:</b> 888	<b>12U:</b> 728 / <b>14U:</b> 799 / <b>16U:</b> 888	<b>12U:</b> 728 / <b>14U:</b> 799 / <b>16U:</b> 888
Height w/ VCU castors (mm)	<b>12U:</b> 800 / <b>14U:</b> 871 / <b>16U:</b> 960	<b>12U:</b> 800 / <b>14U:</b> 871 / <b>16U:</b> 960	<b>1 2U:</b> 800 / <b>14U:</b> 871 / <b>16U:</b> 960
Weight (kg)	102	126	150



Model	<b>Compact</b> (2128)	<b>Mono</b> (2526)	<b>Duplex</b> (2128)	<b>Duet</b> (3000)
Code	V4CC	V4CM	V4CDX	V4CDT
Price	£5,481	£6,132	£7,779	£7,779
Rack space	12U / 14U / 16U		24U / 28U / 32U	24U / 28U / 32U

### INCLUDED

Choice of standard paint & worktop finishes	pg 89	pg 89	pg 89	pg 89
Half U's open in door (std)	✓	✓	✓	✓
Left or right hand	✓	✓	✗	✗
Illuminated branding (vinyl or printed on request)	✓	✓	✓	✓
Monitor arm (ENDO72 or 82)	✓	✓	✓	✓
Rack access	Front & rear door	Front & rear door	Front & rear door	Front & rear door

### ADDITIONAL COST (See all accessories on pg 35)

Non-standard paint & worktop finishes	pg 89	pg 89	pg 89	pg 89
Writing surface inlay	pg 32	pg 32	pg 32	pg 32
Desktop machining	pg 33	pg 33	pg 33	pg 33
Castors	x4	x6	x6	x6

### MEASUREMENTS

Width (mm)	2128	2526	2128	3000
Depth (mm)	1025	1030	1025	1100
Height (mm)	<b>12U:</b> 800 / <b>14U:</b> 871 / <b>16U:</b> 888	<b>12U:</b> 800 / <b>14U:</b> 871 / <b>16U:</b> 888	<b>12U:</b> 800 / <b>14U:</b> 871 / <b>16U:</b> 888	<b>12U:</b> 800 / <b>14U:</b> 871 / <b>16U:</b> 888
Height w/ VCU castors (mm)	<b>12U:</b> 800 / <b>14U:</b> 871 / <b>16U:</b> 960	<b>12U:</b> 800 / <b>14U:</b> 871 / <b>16U:</b> 960	<b>12U:</b> 800 / <b>14U:</b> 871 / <b>16U:</b> 960	<b>12U:</b> 800 / <b>14U:</b> 871 / <b>16U:</b> 960
Weight (kg)	171	188	181	243

# EXPERT RO

EXPERT is a contemporary styled lectern designed to enhance any presentation space. Designed to securely house integrated media equipment, it is suitable for all room sizes. With a removable rack system and illuminated branding, EXPERT is another premium quality offering to suit particular interior designs. It is available with 16U or 32U rack space as standard.

EXPERT incorporates our innovative 19" secure rack unit, that allows non rack-mounted equipment to be fitted and secured within the rack space. The four door access design also allows unrivalled access to the racking system. Modesty panels are included in the price when part of the standard configuration.



Lectern accessories - pg 35

Rack shelves not included, please see pg 9.



Model	<b>Mono</b> (1000)	<b>Mono +</b> (1250)	<b>Mono ++</b> (1500)	<b>Duplex</b> (1500)
Code	V4EM16U	V4EM16UP	V4EM16UPP	V4EDX16U
Price	£4,166	£4,411	£4,770	£6,589
Rack space	16U			32U

### INCLUDED

Choice of standard paint & worktop finishes	pg 89	pg 89
Half U's open in door (std)	✓	✓
Left or right hand	✗	✗
Illuminated branding (vinyl or printed on request)	✓	✓
Monitor arm (ENDO72 or 82)	✓	✓
Concealed castors	x4	x8

### ADDITIONAL COST (See all accessories on pg 35)

Non-standard paint & worktop finishes	pg 89	pg 89
Writing surface inlay	pg 32	pg 32
Desktop machining	pg 33	pg 33

### MEASUREMENTS

Width (mm)	1000	1250	1500	1500
Depth (mm)	750	750	750	750
Height (mm)	920	920	920	920
Weight (kg)	78	81	86	131



Model	<b>Compact</b> (1712)	<b>Standard</b> (2000)	<b>Duet</b> (2100)	<b>Duo</b> (2440)
Code	V4EC16U	V4ES16U	V4EDT16U	V4EDO16U
Price	£5,256	£5,929	£7,779	£8,116
Rack space	16U	32U	32U	32U

### INCLUDED

Choice of standard paint & worktop finishes	pg 89	pg 89	pg 89
Half U's open in door (std)	✓	✓	✓
Left or right hand	✓	✗	✓
Illuminated branding (vinyl or printed on request)	✓	✓	✓
Monitor arm (ENDO72 or 82)	✓	✓	✓
Concealed castors	x6	x8	x6

### ADDITIONAL COST (See all accessories on pg 35)

Non-standard paint & worktop finishes	pg 89	pg 89	pg 89
Writing surface inlay	pg 32	pg 32	pg 32
Desktop machining	pg 33	pg 33	pg 33

### MEASUREMENTS

Width (mm)	1712	2000	2100	2440
Depth (mm)	750	750	750	750
Height (mm)	920	920	920	920
Weight (kg)	109	116	161	165

# BRAVO HA



BRAVO HA range is electronically height adjustable and incorporates our innovative 19" rack unit, which secures both rack and non-rack mounted equipment.

Illuminated corporate branding is included to promote your brand. To complete BRAVO, choose your finish from a wide range of colours, worktops and edge banding options.



Lectern accessories - pg 35

Upgrade to a BRAVO DUET model  
Call us for pricing



Model	Bravo HA (1000)		Bravo HA + (1250)		Bravo HA ++ (1500)	
	8U	12U	8U	12U	8U	12U
Rack space	8U	12U	8U	12U	8U	12U
Code	V5BHA08U	V5BHA12U	V5BHA08UP	V5BHA12UP	V5BHA08UPP	V5BHA12UPP
Price	£4,694	£5,174	£5,174	£5,656	£5,629	£6,080

## INCLUDED

Choice of standard paint & worktop finishes	pg 89
Half U's open in door (std)	✓
Illuminated branding (vinyl or printed on request)	✓
Monitor arm (ENDO72 or 82)	✓
Concealed castors	x4

## ADDITIONAL COST (See all accessories on pg 35)

Non-standard paint & worktop finishes	pg 89
Writing surface inlay	pg 32
Desktop machining	pg 33

## MEASUREMENTS

Width (mm)	1000	1250	1500
Depth (mm)	750	750	750
Height (HA) (mm)	950 - 1200	950 - 1200	950 - 1200
Weight (kg)	135	137	139

● Fixed height models still available POA

# STARLITE



The STARLITE PRESENTER is a mobile height adjustable presentation station with an inclined or flat work-surface, designed to accommodate two visualisers so that the user may easily switch between media or present multiple items simultaneously. Our visualiser housing for the STARLITE features an aperture for a confidence monitor, allowing the lecturer to easily keep track of what is being displayed without the need to divert their attention from the audience.

The unit can be customised to suit the needs of the user with a custom control panel housing and a choice of glass or ceramic writing surface inlays. The additional 2U of top-loading full width storage allows for equipment to be securely concealed.



Lectern accessories - pg 35



2U rack space

Model	STARLITE (1010)
Code	SL2
Price	£4,906
Rack space	2U (within the base unit)

## INCLUDED

Choice of standard paint & worktop finishes	pg 89
Castors	x4
Pen tray	✓

## ADDITIONAL COST (See all accessories on pg 35)

Non-standard paint & worktop finishes	pg 89
Illuminated branding	✓
Vinyl <u>or</u> printed branding	pg 7
Writing surface inlay	pg 32
Desktop machining	pg 33
Monitor arm	pg 80
Castor upgrade (4x braked)	✓
Keyboard shelf	✓

## MEASUREMENTS

Width (mm)	1010
Depth (mm)	960
Height - HA (mm)	910 - 1250
Weight (kg)	110



Writing surface inlay  
(Choose from glass OR ceramic)

# Explorer

Mono 1250



**10-day lead-time**

See options here



Available when purchased with our choice of stocked worktop & edge banding finishes:



Choice of five standard paint finishes:



● Please note: The 10-day lead-time starts when we have received all the correct information to commence manufacture, such as approval of desktop machining, CPH, branding, etc.

RO

# EXPLORER

Available in a single or double unit, EXPLORER is a media integrated lectern focused on small to medium presentation spaces (standard side panel option shown).

Utilising our innovative 16U rack design, which secures both rack and non-rack mounted equipment, EXPLORER is supplied with a flexible monitor arm and concealed castors.

The basic features of an EXPLORER result in a cost effective product with a very competitive lead time.



'Deluxe' wooden side panel option

Lectern accessories - pg 35

Rack shelves not included, please see pg 9.



		Mono			Duplex
Model	1000	1250	1500	1500	
Code - Standard	E2LMS16U08-100	E2LMS16U08-125	E2LMS16U08-150	E2LDXS16U	
Price - Standard	£3,365	£3,595	£3,885	£5,178	
Code - Deluxe (Wooden sides)	E2LMF16U08-100	E2LMF16U08-125	E2LMF16U08-150	E2LDFX16U	
Price - Deluxe (Wooden sides)	£3,512	£3,738	£4,030	£5,320	
Rack space	16U			32U	

### INCLUDED

Choice of standard paint & worktop finishes	pg 89	pg 89
Monitor arm (ENDO72 or 82)	✓	✓
Concealed castors	x4	x4

### ADDITIONAL COST (See all accessories on pg 35)

Non-standard paint & worktop finishes	pg 89	pg 89
Vinyl or printed branding	pg 7	pg 7
Writing surface inlay	pg 32	pg 32
Desktop machining	pg 33	pg 33

### MEASUREMENTS

Width (mm)	1000	1250	1500	1500
Depth (mm)	770	770	770	812
Height (mm)	950	950	950	950
Weight (kg)	69	71	73	120

# CREDENZA RO

CREDENZA is a media integrated free-standing cabinet. Ideal for mid-sized seminar rooms, the CREDENZA sits against the wall to be inconspicuous and efficiently utilise space.

Featuring an innovative 16U rack design, which secures both rack and non-rack mounted equipment accessible by front and rear doors, CREDENZA is supplied with an ENDO monitor arm for added security & either standard steel or deluxe wooden side panels.



Lectern accessories - pg 35

Rack shelves not included, please see pg 9.



Model	<b>Mono</b> (740)	<b>Duplex</b> (1440)
Code - Standard	E1CMS16U	E1CDXS16U
Price - Standard	£3,669	£5,249
Code - Deluxe (Wooden sides)	E1CMF16U	E1CDXF16U
Price - Deluxe (Wooden sides)	£3,812	£5,394
<b>Rack space</b>	<b>16U</b>	<b>32U</b>

### INCLUDED

Choice of standard paint & worktop finishes	pg 89
Monitor arm (ENDO72 or 82)	✓
Concealed castors	x4

### ADDITIONAL COST (See all accessories on pg 35)

Non-standard paint & worktop finishes	pg 89
Vinyl or printed branding	pg 7
Writing surface inlay	pg 32
Desktop machining	pg 33

### MEASUREMENTS

Width (mm)	740	1440
Depth (mm)	641	641
Height (mm)	950	950
Weight (kg)	69	120



Solid Door (00)



Half Open (8U)



Half Glazed (HG)



Full Glazed (FG)

● Please be sure to specify your door style(s) when ordering.

# RUBI RO

RUBI is an economical media cabinet for small rooms. It is a compact solution allowing it to be placed in areas where space is limited. All four sides of the RUBI are lockable and detachable from the frame providing easy access to equipment.

The standard unit comes with six power sockets and 16U half / 5U full rack space (see information below) with half of the rack space accessible to the user through apertures that may be adjusted to suit your access requirements.



10-day\* lead-time

16U horizontal rack space (350mm depth)

5U vertical rack space (500mm depth)

Lectern accessories - pg 35



Model	<b>Mono</b> (725)	<b>Mono +</b> (1200)
Code	R2L-072	R2L-120
Price	£1,416	£1,576

<b>Rack space</b>	<b>16U half / 5U full (vertical)</b>
-------------------	--------------------------------------

### INCLUDED

Choice of standard paint & worktop finishes	pg 89
On-board power (6-gang)	✓
Concealed castors	x4
Rack shelves	✓
Half U's open / fully enclosed panel (std)	✓

### ADDITIONAL COST (See all accessories on pg 35)

Non-standard paint & worktop finishes	pg 89
Vinyl or printed branding	pg 7
Writing surface inlay	pg 32
Desktop machining	pg 33
Monitor arm (ENDO72 or 82)	pg 82
2-tone colour finish	✓ (standard colours)

### MEASUREMENTS

Width (mm)	725	1200
Depth (mm)	500	560
Height (mm)	900	900
Weight (kg)	45	55

● Please note: Rubi Mono+ 10-day lead-time is only available in standard colours and finishes (please see pg 23).



Rack access



Concealed castors

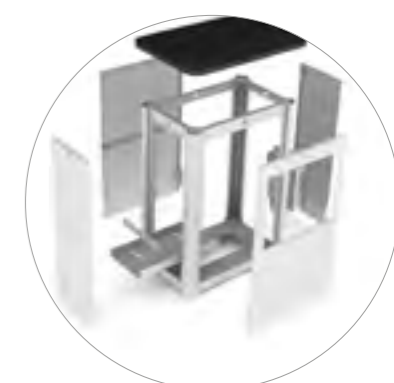

Detachable sides



# MESSENGER

MESSENGER is an elegant and stylish podium suitable for a wide range of presentation spaces with minimal footprint. MESSENGER is electrically height adjustable to suit all presenters.

The lectern rises and falls at the push of a button and depending on models selected can be configured with wireless or corded microphones, PCs and other AV technology.

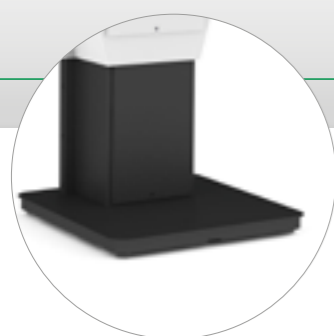

Static  
(Base plate w/o castors)

Lectern accessories - pg 35

Rack shelves not included, please see pg 9.



Model	<b>M1P</b> (665)	<b>M2P</b> (786)	<b>M3P4U</b> (1000)	<b>M3P8U</b> (1000)
Code - Horizontal Top	M1P*H	M2P*H	M3P4U	M3P8U
Code - Angled Top	M1P*A	M2P*A	-	-
Price	£2,690	£3,733	£4,039	£4,340

Rack space	-	4U half	4U full	8U full
------------	---	---------	---------	---------

### INCLUDED

Choice of standard paint & worktop finishes	pg 89	pg 89	pg 89	pg 89
Secure access door	X	✓	✓	✓
PC aperture	X	✓	✓	✓

### ADDITIONAL COST (See all accessories on pg 35)

Non-standard paint & worktop finishes	pg 89	pg 89	pg 89	pg 89
Vinyl or printed branding	pg 7 (vinyl only)	pg 7 (vinyl only)	pg 7	pg 7
Writing surface inlay	pg 32	pg 32	pg 32	pg 32
Desktop machining	pg 33	pg 33	pg 33	pg 33
Monitor arm (ENDO72 or 82)	X	X	pg 82	pg 82

### MEASUREMENTS

Width (mm)	665	786	1000	1000
Depth (mm)	518	570	721	728
Height (mm)	870 - 1200	870 - 1200	730 - 1060	830 - 1130
Weight (kg)	47	50	75	80



# MESSENGER MOBILE

Available with castors as displayed, for improved mobility and versatility of space. Castor style may vary dependent on model.



w/ castors



Model	<b>M1P-C</b> (665)	<b>M2P-C</b> (786)	<b>M3P4U-C</b> (1000)	<b>M3P8U-C</b> (1000)
Code - Flat Top	M1P-C*H	M2P-C*H	M3P4U-C	M3P8U-C
Code - Angled Top	M1P-C*A	M2P-C*A	-	-
Price	£3,168	£4,144	£4,602	£4,903

Rack space	-	4U half	4U full	8U full
------------	---	---------	---------	---------

### INCLUDED

Choice of standard paint & worktop finishes	pg 89	pg 89	pg 89	pg 89
Secure access door	X	✓	✓	✓
PC aperture	X	✓	✓	✓
Concealed castors	x4	x4	x4	x4

### ADDITIONAL COST (See all accessories on pg 35)

Non-standard paint & worktop finishes	pg 89	pg 89	pg 89	pg 89
Vinyl or printed branding	pg 7 (vinyl only)	pg 7 (vinyl only)	pg 7	pg 7
Writing surface inlay	pg 32	pg 32	pg 32	pg 32
Desktop machining	pg 33	pg 33	pg 33	pg 33
Monitor arm (ENDO72 or 82)	X	X	pg 82	pg 82

### MEASUREMENTS

Width (mm)	665	786	1000	1000
Depth (mm)	518	570	721	728
Height (mm)	870 - 1200	870 - 1200	730 - 1060	880 - 1180
Weight (kg)	47	50	75	80



# JUNO RO

JUNO, an elegant wall mounted presentation station suitable for a wide range of smaller spaces or reception areas.

The screen can either be mounted to the wall or on an articulated ENDO monitor arm for security (additional cost).

JUNO features a housing underneath for a PC and tidy internal cable management, creating the perfect space saving unit.



## SLIMLINE ACTIVE LEARNING CONSOLE / SLIMLINE ACTIVE LEARNING BAR

This range of SLIMLINE ACTIVE LEARNING CONSOLES & BARS are specifically designed to help integrate AV/IT into smaller learning environments, drastically reducing the footprint of the technical furniture within the space.

Perfect for bringing AV over IP into smaller learning environment and facilitating full AV integration to smaller, under-used spaces.



11U horizontal rack space (350mm depth)  
5U vertical rack space (500mm depth)

Lectern accessories - pg 35



Model	JUNO A (730)	JUNO B (800)	JUNO C (800)
Code	JUNO-A	JUNO-B	JUNO-C
Price	£1,294	£2,005	£2,111
Rack space	-	11U half / 5U full (vertical)	

### INCLUDED

	pg 89	pg 89	pg 89
Choice of standard paint & worktop finishes	pg 89	pg 89	pg 89
3x rack shelves	N/A	✓	✓

### ADDITIONAL COST (See all accessories on pg 35)

Gravity height adjustment	✓	✓	✓
Vinyl or printed branding	pg 7	pg 7 (vinyl only)	pg 7
Desktop machining	pg 33	pg 33	pg 33
485-Y01 screen mount	pg 81	pg 81	pg 81
Monitor arm (ENDO72 or 82)	pg 82	pg 82	pg 82
CPH single aperture JUNO-CPH-TBH-SA	✓	✓	✓
CPH multiple aperture JUNO-CPH-TBH-MA	✓	✓	✓
Electric height adjustment	N/A	£1,413	£1,519
Cable cover below unit	£260	£260	£260

### MEASUREMENTS

Width (mm)	730	800	800
Depth (mm)	480	500	500
Height (mm)	470	700	700
Weight (kg)	20	25	25

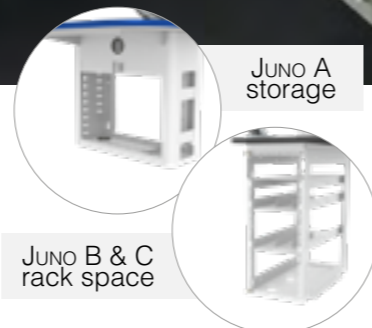

JUNO A storage



JUNO B & C rack space



JUNO B & C rack space  
Access door on JUNO C only



Electric height adjustment  
Able to accommodate up to **70kg** of equipment on the unit

**Please note:**  
JUNO worktops are supplied plain. Please specify desktop machining when ordering.



Configured to your AV requirements

Lectern accessories - pg 35



Model	SALC	SALC Mini	SALB
Code	SALC20WM	SALC10WM	SALB
Price	£1,494	£1,360	£1,272

### INCLUDED (SALC only, SALB configured on purchase)

	pg 89	pg 89
Choice of standard paint finishes	pg 89	pg 89
Space for a small PC	✓	✗
Lockable front panel	✓	✓
Hook on shelves	✓	✗

### ADDITIONAL COST

Non-standard paint finishes	pg 89	pg 89
Vinyl or printed branding	pg 7	pg 7
Punched branding	✓	✓
Bespoke connectivity inputs	✓	✓

### MEASUREMENTS

Width (mm)	~500	~500	~867
Depth (mm)	~90	~90	~106
Height (mm)	~720	~382	~146
Weight (kg)	~19	~12	~8

**Please note:** All SALC models are supplied blank as standard.

# CABLE RACEWAY <sup>D</sup>

CABLE RACEWAY is a cable management system that incorporates multiple channels for separation of power and data.

Built to withstand the demanding requirements of modern offices and locations with heavy traffic; its top loaded design brings an end to awkward cable runs. We recommend that the CABLE RACEWAY should be fixed to the floor for a better quality installation.

CABLE RACEWAY uses interlocking modular components to help keep cables tidy, protected and free from damage.

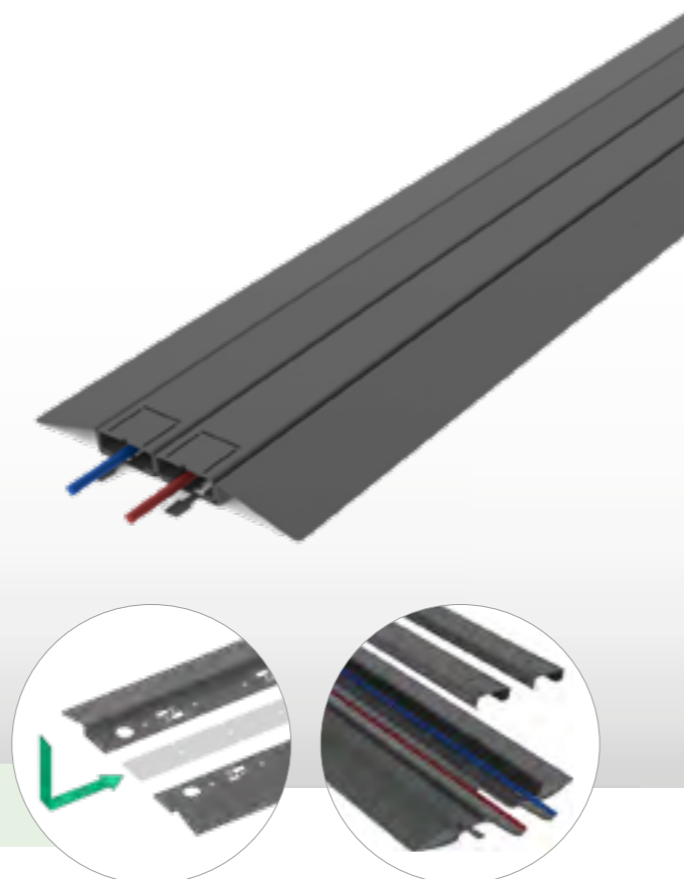

CABLE RACEWAY has been designed to be modular, enabling you to easily add additional cable channels through the use of width extensions.



Model	1000 Section	500 Section	250 Section	90° Corner (2 Channel)	90° Corner (3 Channel)
Code	CBLRCWY1000	CBLRCWY050	CBLRCWY025	CBLRCWYCOR	CBLRCWYCOR3
Price	£329	£275	£262	£250	£305

## MEASUREMENTS

	1000 Section	500 Section	250 Section	90° Corner (2 Channel)	90° Corner (3 Channel)
Width (mm)	267	267	267	295	355
Length (mm)	1000	500	250	295	355
Height (mm)	21	21	21	21	21



Model	1000 Width Extension	500 Width Extension	250 Width Extension	End Cap (2 Channel)	End Cap (3 Channel)
Code	CBLRCWY1000EXT	CBLRCWY050EXT	CBLRCWY025EXT	CBLRCWYEND	CBLRCWYEND3
Price	£181	£162	£153	£153	£305

## MEASUREMENTS

	1000 Width Extension	500 Width Extension	250 Width Extension	End Cap (2 Channel)	End Cap (3 Channel)
Width (mm)	59	59	59	267	327
Length (mm)	1000	500	250	176	176
Height (mm)	21	21	21	21	21

# WRITING CAPTURE SURFACES

## Glass or Ceramic Inlay

Our glass and ceramic inlay surfaces help make your presentation space more effective, enabling you to write directly onto the worktop or present your work on the screen utilising visualiser technology. Choose your finish to optimise visualiser quality on the presentation screen.

### Please note:

- Wet wipe is a surface for a "damp" not "wet" cloth.
- If below 20% gloss you will experience fewer reflection issues.

## AUDIO VISUAL LECTERNS

» Our write-on surfaces for lecterns, coupled with an appropriate visualiser, allow you to effectively display content through projection equipment on the fly.

## SYNERGY

- » Use these surfaces for collaboration and sharing without printing and distribution.
- » Collaborative meetings are easily documented using modern technology; brainstorm, take notes and other details you usually write on a notepad.
- » Facilitate your digital document management system by using furniture that allows meeting notes and ideas in the office to be shared, scanned and stored electronically.
- » Whether you are presenting notes via visualiser to the screen, writing on the fly, annotating physical items or simply avoiding printing endless copies, the advantage of a quality-writing surface is self evident.

## AUDIO VISUAL LECTERNS & COLLABORATIVE TABLES

CODE	DESCRIPTION	PRICE
ILP-G	Glass Inlay - Dry Wipe	£715
ILP-CD	Ceramic Inlay - Dry Wipe	£605
ILP-CW	Ceramic Inlay - Wet Wipe	£605
-	STARLITE (see pg 22) Uplift for second writing surface inlay	+£93 uplift

- Smaller and larger sizes available POA up to a certain size
- Inlay panel sizes are made according to customer requirements
- Grid markings are available at additional cost



# DESKTOP MACHINING

We offer a DESKTOP MACHINING service on all lecterns that is completely customisable to your requirements, ensuring the consistency of hole sizes and locations. This service reduces disruption and dust on site or in rack build environments.

We have desktop templates available for all of our products where this service is offered. We need an approved layout in order to proceed.

We can work from CAD (preferred) or an annotated PDF image.

Delivery lead time for DESKTOP MACHINING is 10 working days from sign off to delivery date. Sign off notice shorter than this will lead to potential delays, please discuss with your account manager prior to your order.

CODE	PRICE
DESKTOP-MACHINING	£187 per desktop

## Additional Option - Desktop Machining & Underside Integrated Cable Channel

(Only available in combination with DESKTOP MACHINING)

With our in-house machining service, we also offer the option to integrate wiring into the worktop using cable channels.

This improves cable management for overhanging worktops allowing power and data leads to connect straight from the body of the lectern to the device without leaving any trailing cables.

For more information, please don't hesitate to contact a TOP-TEC sales advisor.

CODE	PRICE
DESKTOP-MACHINING-ICC	+ £187 per desktop (Additional cost to DESKTOP MACHINING)



# LECTERN ACCESSORIES

RO D



NAME	MODEL	DESCRIPTION	PRICE
Rounded Control Panel Housing	RCPH-SINGLE-APERTURE	Single aperture	£260
	RCPH-MULTIPLE-APERTURE	Multiple aperture	£457
	RCPH-OVERSIZE	> 700mm width	£503
	RCPH-EXTRASOCKET	Additional mains socket	+ £53
Standard Control Panel Housing	RCPH-LOCKABLE	Lockable	+ £119
	CPH-XXX	-	Same as above
Tablet Control Housings	TCH	Made to measure for any tablet model	£457
	TCH-EXTRASOCKET	Additional mains socket	+ £53
Jacking Castors Also compatible with ARIES & GEMINI	VCU4	Set of 4 castors	£308
	VCU6	Set of 6 castors	£470
	VCU8	Set of 8 castors	£619
Low Profile Castors ARIES, GEMINI	GCU4	Set of 4 castors	£223
	GCU6	Set of 6 castors	£338
	GCU8	Set of 8 castors	£447
Premium Castor Upgrade	-	Castor upgrade	POA
Secure Rack Drawer	NEP-DRAWER1-L	387mm (d)	£292
	NEP-DRAWER2-L	352mm (d)	£292
Additional Sockets	NEP-EXT06	6 gang extension lead	£51
	NEP-EXT10	10 gang extension lead	£69
Front Blank Plate	NEP-BLANK-1U	1U Front Blank Plate	£25
	NEP-BLANK-2U	2U Front Blank Plate	£36
	NEP-BLANK-3U	3U Front Blank Plate	£44
	NEP-BLANK-4U	4U Front Blank Plate	£49

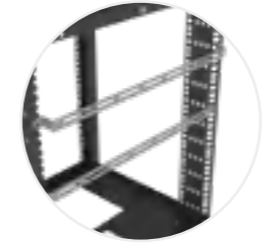
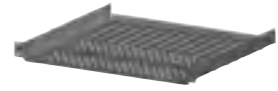

NAME	MODEL	DESCRIPTION	PRICE
Rack Shelves	100-495-10	100mm (d)	£88
	100-495-17	170mm (d)	£99
	100-495-25	250mm (d)	£107
Additional Shelves	NEP-SHELF37	370mm (d)	£110
	NEP-SHELF41	410mm (d)	£110
	NEP-SHELF46	460mm (d)	£110
Rack Lacing Bar	100-583-19/00	With no offset	£44
	100-583-19/25	With 25mm offset	£44
Visualiser Housing	100-B	Custom made for specific visualiser models	£526
Vinyl Branding	NBRAND	High quality vinyl print of your logo applied to the front of the lectern	£150
Vinyl Wrap - Full Door	NWRAP	High quality vinyl print of your branding as a full door wrap, applied to the lectern	£578
Illuminated Branding	VBRAND	High quality cut outs of your logo into the metal work, with a choice of colours to illuminate your logo	Inc. on selected models
Printed Branding	PBRAND	High quality version of your branding printed directly onto the metalwork on the front of the lectern	£150

# NEPTUNE RACK CABINET RO

NEPTUNE RACK CABINET is a secure, patented media mounting unit offering superb storage and functionality for AV equipment. The cabinet features an innovative shelving system that has adjustable side stops to prevent the media equipment from moving around and are kept secure with high quality security locks.

There is a removable mounting plate for power distribution and has half of a rack unit open for user access as standard. The user has the option to fix the unit to the wall or floor or to have the cabinet mounted on castors, at an additional cost.



Branding not available on this product

Model	NEPTUNE-06	NEPTUNE-08	NEPTUNE-12	NEPTUNE-14	NEPTUNE-16
Price	£942	£1,030	£1,205	£1,295	£1,447
Rack space	6U	8U	12U	14U	16U

## SHELVES

370mm deep	1	1	1	1	1
410mm deep	2	2	2	2	2

## DIMENSIONS

Width (mm)	523	523	523	523	523
Depth (mm)	545	545	545	545	545
Height (mm)	444	533	711	800	889

## ABOVE PRODUCT WITH EXTRA DEPTH

Depth (mm)	630	630	630	630	630
Code	NEPTUNE-06XD	NEPTUNE-08XD	NEPTUNE-12XD	NEPTUNE-14XD	NEPTUNE-16XD
Price	£1,146	£1,248	£1,439	£1,482	£1,642

## BACK PANEL

Code	NEP-BACK-06	NEP-BACK-08	NEP-BACK-12	NEP-BACK-14	NEP-BACK-16
Price	£164	£170	£189	£197	£207

Other sizes available POA

# NEPTUNE ACCESSORIES RO D

NAME	MODEL	DESCRIPTION	PRICE
	NEP-TOP	350mm (w) 530mm (d)	£110
	NEP-TOP-XD	Extra deep	£167
	NEP-FOLDSHELF	350mm (w) x 530mm (d)	£214
	NEP-FOLDSHELF-XD	Extra deep	£308
	NEP-DRAWER-L	2U secure drawer 387mm	£292
	NEP-DRAWER2-L	2U secure drawer 352mm	£292
	NEP-KEYBRDSHELF	Holds keyboard up to 360mm (w) x 260mm (d)	£319
	NEP-SHELF37	370 mm (d)	£110
	NEP-SHELF41	410 mm (d)	£110
	NEP-SHELF46	460 mm (d)	£110
	SSO-1	13A metal socket outlet, top extension cut-out and backbox.	£195
	NEP-CPH	Bespoke casing for control units	£197
	NEP-CPH-MA		£295
	NEP-BLANK-1U	1U Front Blank Plate	£25
	NEP-BLANK-2U	2U Front Blank Plate	£36
	NEP-BLANK-3U	3U Front Blank Plate	£44
	NEP-BLANK-4U	4U Front Blank Plate	£49
	485V2	Secure bracket with tilt and 360° swivel	£202
	NEP-EXT-06	6 gang extension lead	£51
	NEP-EXT-10	10 gang extension lead	£69
	ENDO82	Stylish and contemporary design with full 360° rotation	£215
	ENDO72		£215
	NEP-TETHER-10-I	1000mm tether	£96
	NEP-TETHER-15-I	1500mm tether	£99
	NEP-TETHER-20-I	2000mm tether	£105
	NEP-CASTOR-BRAKED	80mm castors (set of 4) 2 of 4 braked	£220

# Collaborative Tables

Collaborative tables allow users to come together for group projects and discussions where they can share information and ideas seamlessly. TOP-TEC builds furniture that seamlessly integrates technology to create innovative collaborative areas and agile working environments.



## Collaboration is key!

Creating active learning environments to enhance student collaboration.



## Communicate & share ideas

Our table shapes help promote discussion and enhance engagement.



## Make it your own!

We can colour match to meet any of your branding requirements.



## Tamper proof solution

Keep cables locked away, eliminating any potential tampering.



## Facilitates seamless AV/IT integration

Complete cable management creates an 'all-in-one' solution.



## Range of models

Our tables range from 2-seat huddles to 20-seat boardrooms.



# SYNERGY FUSION

ROE

SYNERGY FUSION is a flexible solution designed to give the user the ability to create different learning environments to suit their teaching style on the day. The unit can be used as a traditional display while the screen is raised and can also be retracted when it is not needed, providing clear line of sight for students.



suitable for 42-50" VESA 400x400



Model	Plectrum 6-seat	Quad 6-seat	Blade 6-seat	Teardrop 6-seat	Reverse Plectrum 5-seat
Code	SY4FPM06	SY4FQD06	SY4FBE06	SY4FTD06	SY4FPM05R
Price	£7,158	£7,158	£7,158	£7,158	£7,158

Rack space: 2x 1U top loading internal rack space

### INCLUDED

Choice of standard paint & worktop finishes	pg 89
Soft close lid	✓
Piezo anti collision system	✓
Standard connectivity	✓
Data interface plate: 1x 13A socket	
Cable well: 3x HDMI + 1x MiniDP	

### ADDITIONAL COST (See all accessories on pg 59)

Non-standard paint & worktop finishes	pg 89
'Shark-nose' worktop edge	pg 92
Desktop machining	pg 33
Bespoke connectivity	pg 54

# SYNERGY ATMOS

ROE

SYNERGY ATMOS features a high quality fabric panel behind the screen which gives more focus to the meeting space and limits distractions.

These innovative and dynamic meeting space helps focus the meeting and limit external distractions.

## Reduce costs + save resources

Parachute fully integrated meetings spaces into your learning environments with minimal impact on infrastructure.

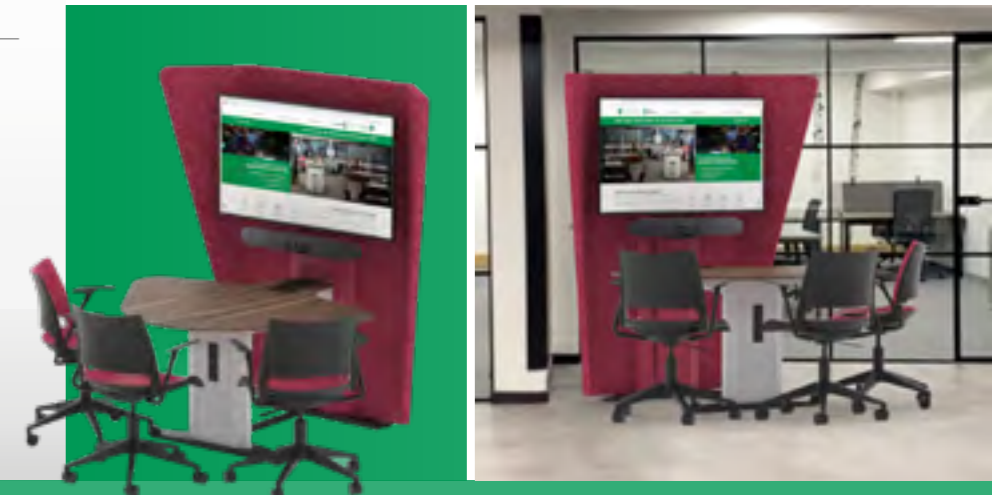

1250mm(W) screens



Model	Teardrop 2-seat	Reverse Plectrum 3-seat	Reverse Plectrum 5-seat	Blade 4-seat	Blade 6-seat
Code	SY4ATD02	SY4APM03R	SY4APM05R	SY4ABE04	SY4ABE06
Price	£6,439	£7,106	£7,373	£7,106	£7,373

### INCLUDED

Choice of standard paint & worktop finishes	pg 89
High quality fabric shroud	Group 1 Fabric
Screen mount (VESA) JLITE-01 or JLITE-02	01 - 400x400 02 - 700x400 up to 1250mm(W) screens
Standard connectivity	pg 53
PC cage	pg 59
Secure (318Z) or non-secure (240Z)	
'Shark-nose' worktop edge	pg 92

### ADDITIONAL COST (See all accessories on pg 59)

Non-standard paint & worktop finishes	pg 89
Premium fabric options	e.g. two-tone / patterns
Desktop machining	pg 33
Bespoke connectivity	pg 54
Colour match your fabric shroud to the metalwork	POA

# SYNERGY QUAD



Classic worktop shape ideal for face to face meetings and collaborative activities.

The QUAD combines high quality materials and classic design ideas with integrated technology; creating a positive first impression with users to share visual information and promoting positive interaction.

Create enriched meeting environments where colleagues can share content, discuss ideas and collaborate around a shared screen. This allows the creation of instant meeting spaces with minimal impact on existing infrastructure whilst a full range of finishing options ensure you bring your furniture in line with your brand identity.

Collaborative table accessories - pg 59



Model	4-seat	5-seat	6-seat	8-seat
Code	SY4QD04	SY4QD05	SY4QD06	SY4QD08
Price	£5,131	£5,398	£5,398	£6,729

**INCLUDED**

Choice of standard paint & worktop finishes	pg 89
Screen mount (VESA) JUPITER01-PBL or JUPITER02-PBL	01 - 400x400 02 - 700x400
Standard connectivity	pg 53
PC cage Secure (318Z) or non-secure (240Z)	pg 59

**ADDITIONAL COST** (See all accessories on pg 59)

Non-standard paint & worktop finishes	pg 89
'Shark-nose' worktop edge	pg 92
Larger screen mount (VESA) JUPITER03-PBL	pg 59 03 - 800x600
Desktop machining	pg 33
Bespoke connectivity	pg 54

**MEASUREMENTS**

Width (mm)	1020	1120	1020	1020
Depth (mm)	1778	1978	2427	3117
Worktop height (mm)	730 / 990	730 / 990	730 / 990	730 / 990
Weight (kg)	90	95	102	121



Model	10-seat	12-seat	14-seat	16-seat	20-seat
Code	SY4QD10	SY4QD12	SY4QD14	SY4QD16	SY4QD20
Price	£7,130	£7,729	£9,900	£13,200	£18,150

**INCLUDED**

Choice of standard paint & worktop finishes	pg 89
Screen mount (VESA) JUPITER01-PBL or JUPITER02-PBL	01 - 400x400 02 - 700x400
Standard connectivity	pg 53
PC cage Secure (318Z) or non-secure (240Z)	pg 59

**ADDITIONAL COST** (See all accessories on pg 59)

Non-standard paint & worktop finishes	pg 89
'Shark-nose' worktop edge	pg 92
Larger screen mount (VESA) JUPITER03-PBL	pg 59 03 - 800x600
Desktop machining	pg 33
Bespoke connectivity	pg 54

**MEASUREMENTS**

Width (mm)	1500	1500	1500	1797	1703
Depth (mm)	3617	4266	5061	5686	6943
Worktop height (mm)	730 / 990	730	730	730	730
Weight (kg)	181	204	250	300	370



ROE

# SYNERGY BLADE



Expanded worktop to allow more contributors to fit at the end of the table, with the screen still being used as a primary resource.

Synergy Blade has been designed incorporating characteristics from the SYNERGY PLECTRUM REVERSE and QUAD shapes.

SYNERGY is designed to provide users with a dynamic and interactive solution that is fully AV and IT integrated and meets the high standard expected from educational furniture today.



Collaborative table accessories - pg 59



Model	<b>4-seat</b>	<b>6-seat</b>	<b>8-seat</b>
Code	SY4BE04	SY4BE06	SY4BE08
Price	£5,131	£5,398	£6,729

**INCLUDED**

Choice of standard paint & worktop finishes	pg 89
Screen mount (VESA) JUPITER01-PBL or JUPITER02-PBL	01 - 400x400 02 - 700x400
Standard connectivity	pg 53
PC cage Secure (318Z) or non-secure (240Z)	pg 59

**ADDITIONAL COST** (See all accessories on pg 59)

Non-standard paint & worktop finishes	pg 89
'Shark-nose' worktop edge	pg 92
Larger screen mount (VESA) JUPITER03-PBL	pg 59 03 - 800x600
Desktop machining	pg 33
Bespoke connectivity	pg 54

**MEASUREMENTS**

Width (mm)	1420	1420	1420
Depth (mm)	1819	2300	2905
Worktop height (mm)	730 / 990	730 / 990	730 / 990
Weight (kg)	95	102	117



Model	<b>10-seat</b>	<b>12-seat</b>
Code	SY4BE10	SY4BE12
Price	£7,130	£7,729

**INCLUDED**

Choice of standard paint & worktop finishes	pg 89
Screen mount (VESA) JUPITER01-PBL or JUPITER02-PBL	01 - 400x400 02 - 700x400
Standard connectivity	pg 53
PC cage Secure (318Z) or non-secure (240Z)	pg 59

**ADDITIONAL COST** (See all accessories on pg 59)

Non-standard paint & worktop finishes	pg 89
'Shark-nose' worktop edge	pg 92
Larger screen mount (VESA) JUPITER03-PBL	pg 59 03 - 800x600
Desktop machining	pg 33
Bespoke connectivity	pg 54

**MEASUREMENTS**

Width (mm)	1484	1484
Depth (mm)	3611	4143
Worktop height (mm)	730	730
Weight (kg)	204	204

# SYNERGY TEARDROP

ROE



Specifically designed to encourage collaboration and interaction between all users.

SYNERGY TEARDROP is a collaborative activity space for small group meetings with up to six contributors using a shared screen.

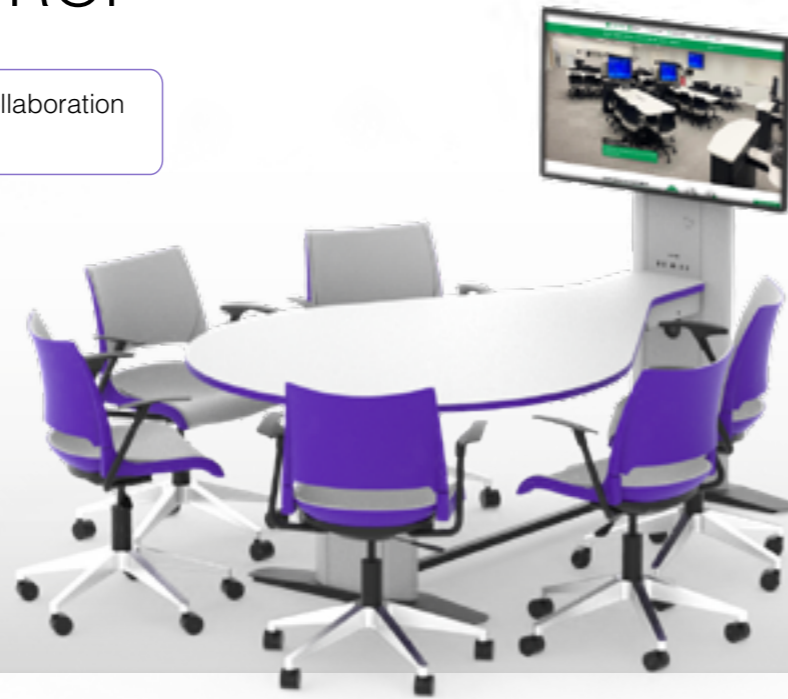

Collaborative table accessories - pg 59



Model	<b>2-seat</b>	<b>6-seat</b>
Code	SY4TD02	SY4TD06
Price	£4,464	£5,398

INCLUDED	
Choice of standard paint & worktop finishes	pg 89
Screen mount (VESA) JUPITER01-PBL or JUPITER02-PBL	01 - 400x400 02 - 700x400
Standard connectivity	pg 53
PC cage Secure (318Z) or non-secure (240Z)	pg 59

ADDITIONAL COST (See all accessories on pg 59)	
Non-standard paint & worktop finishes	pg 89
'Shark-nose' worktop edge	pg 92
Larger screen mount (VESA) JUPITER03-PBL	pg 59 03 - 800x600
Desktop machining	pg 33
Bespoke connectivity	pg 54

MEASUREMENTS		
Width (mm)	850	1350
Depth (mm)	1261	2174
Worktop height (mm)	730 / 990	730 / 990
Weight (kg)	75	99

# SYNERGY PLECTRUM

ROE



Promotes group focus, collaboration and engagement using the screen as a resource.

SYNERGY PLECTRUM is ideal for the creation of Technology Enhanced Active Learning (TEAL) Environments that are used for lectures, group work and as interactive environments.

TEAL environments have been shown to increase the attainment levels in education and the effectiveness of meetings in the commercial world.



Collaborative table accessories - pg 59

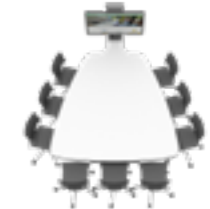

Model	<b>6-seat</b>	<b>9-seat</b>
Code	SY4PM06	SY4PM09
Price	£5,398	£6,729

INCLUDED	
Choice of standard paint & worktop finishes	pg 89
Screen mount (VESA) JUPITER01-PBL or JUPITER02-PBL	01 - 400x400 02 - 700x400
Standard connectivity	pg 53
PC cage Secure (318Z) or non-secure (240Z)	pg 59

ADDITIONAL COST (See all accessories on pg 59)	
Non-standard paint & worktop finishes	pg 89
'Shark-nose' worktop edge	pg 92
Larger screen mount (VESA) JUPITER03-PBL	pg 59 03 - 800x600
Desktop machining	pg 33
Bespoke connectivity	pg 54

MEASUREMENTS		
Width (mm)	1440	2032
Depth (mm)	1924	3072
Worktop height (mm)	730 / 990	730
Weight (kg)	96	143

# SYNERGY REVERSE PLECTRUM ROE



Ideal for video conferencing, where the screen has focus for the group enabling a camera to pan the meeting contributors.

SYNERGY PLECTRUM REVERSE is also available at a 'coffee table' height (440mm). This configuration can be partnered with soft seating options to create the ideal solution for breakout meeting spaces.



Collaborative table accessories - pg 59

# SYNERGY HA ROE



Facilitates the particular needs for a user with special height requirements.

In addition, the electrically height adjustable area rises sufficiently to be used as a presentation point to a small group.



Equality Act compliance

Collaborative table accessories - pg 59



Model	<b>3-seat</b>	<b>3-seat</b>	<b>5-seat</b>	<b>7-seat</b>
Code	SY4PM03R-440	SY4PM03R	SY4PM05R	SY4PM07R
Price	£5,131	£5,131	£5,398	£5,931

## INCLUDED

Choice of standard paint & worktop finishes	pg 89
Screen mount (VESA) JUPITER01-PBL or JUPITER02-PBL	01 - 400x400 02 - 700x400
Standard connectivity	pg 53
PC cage SSecure (318Z) or non-secure (240Z)	pg 59

## ADDITIONAL COST (See all accessories on pg 59)

Non-standard paint & worktop finishes	pg 89
'Shark-nose' worktop edge	pg 92
Larger screen mount (VESA) JUPITER03-PBL	pg 59 03 - 800x600
Desktop machining	pg 33
Bespoke connectivity	pg 54

## MEASUREMENTS

Width (mm)	1440	1440	1440	1440
Depth (mm)	1372	1372	2271	2675
Worktop height (mm)	440	730 / 990	730 / 990	730 / 990
Weight (kg)	78	85	96	125



Model	<b>5-seat</b>	<b>7-seat</b>
Code	SY4PM05REHA	SY4PM07REHA
Price	£6,437	£6,969

## INCLUDED

Choice of standard paint & worktop finishes	pg 89
Screen mount (VESA) JUPITER01-PBL or JUPITER02-PBL	01 - 400x400 02 - 700x400
Standard connectivity	pg 53
PC cage Secure (318Z) or non-secure (240Z)	pg 59

## ADDITIONAL COST (See all accessories on pg 59)

Non-standard paint & worktop finishes	pg 89
'Shark-nose' worktop edge	pg 92
Larger screen mount (VESA) JUPITER03-PBL	pg 59 03 - 800x600
Desktop machining	pg 33
Bespoke connectivity	pg 54

## MEASUREMENTS

Width (mm)	1440	1440
Depth (mm)	2265	2988
Height - HA panel (mm)	730 - 1140	730 - 1140
Worktop height (mm)	730	730
Weight (kg)	125	135

# SYNERGY 'SIT-STAND'

ROE 

Our SYNERGY COLLABORATIVE TABLES are available with a fully height adjustable worktop where the whole surface rises and falls to suit user preference.

The height adjustable functionality allows users to choose between traditional meetings at seated height typically with a longer duration, or at standing height, encouraging quick touchdown and breakout meetings.

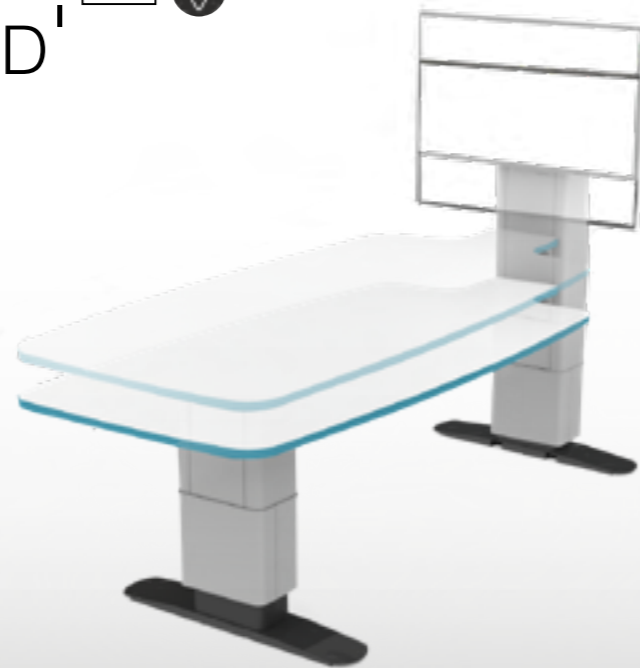

Equality Act compliance

Collaborative table accessories - pg 59

Bespoke designs available



Model	<b>Blade 6-seat</b>	<b>Quad 6-seat</b>	<b>Quad 8-seat</b>
Code	SY4BE06-HA	SY4QD06-HA	SY4QD08-HA
Price	£7,130	£7,130	£8,462

## INCLUDED

Choice of standard paint & worktop finishes	pg 89
Screen mount (VESA) JUPITER01-PBL or JUPITER02-PBL	01 - 400x400 02 - 700x400
Standard connectivity	pg 53
PC cage Secure (318Z) or non-secure (240Z)	pg 59

## ADDITIONAL COST (See all accessories on pg 59)

Non-standard paint & worktop finishes	pg 89
'Shark-nose' worktop edge	pg 92
Larger screen mount (VESA) JUPITER03-PBL	pg 59 03 - 800x600
Desktop machining	pg 33
Bespoke connectivity	pg 54

## MEASUREMENTS

Width (mm)	1420	1020	1020
Depth (mm)	2380	2502	3190
Height - HA worktop (mm)	740 - 1000	740 - 1000	740 - 1000
Weight (kg)	150	150	159

# SYNERGY FOLDING

ROE

SYNERGY FOLDING is highly effective where space is at a premium, room use is varied and multi-use changeover times need to be short.

The table is easily converted into a mobile item in less than three minutes and fits through a standard door when folded.

SYNERGY FOLDING is available in BLADE, QUAD, PLECTRUM & REVERSE PLECTRUM worktop shapes. Please ask for guidance.



fold away in under 3 MINS

Collaborative table accessories - pg 59



Model	<b>Plectrum 6-seat</b>	<b>Quad 6-seat</b>
Code	SY4PM06F	SY4QD06F
Price	£6,063	£6,063

## INCLUDED

Choice of standard paint & worktop finishes	pg 89
Swivel screen mount (VESA)	400x400
Standard connectivity	pg 53
PC cage Secure (318Z) or non-secure (240Z)	pg 59

## ADDITIONAL COST (See all accessories on pg 59)

Dual screen mount	X
Non-standard paint & worktop finishes	pg 89
'Shark-nose' worktop edge	pg 92
Desktop machining	pg 33
Bespoke connectivity	pg 54

## MEASUREMENTS

Width (mm)	1440	1020
Depth (mm)	1920	2422
Worktop height (mm)	730	730
Weight (kg)	127	136

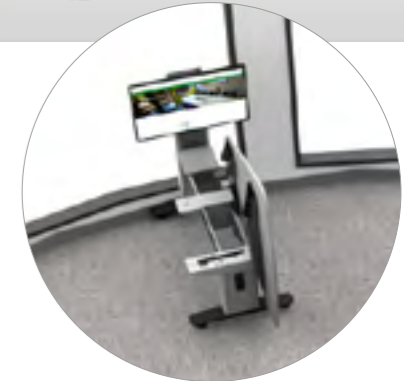

Folded configuration



Table configuration

# STANDARD DATA INTERFACE PLATES

Through our HDMI switch, you may choose to mix and match connections such as **USB C, Mini DisplayPort** and **HDMI**, see example standard configurations below.

Illustrated: Cable Connectivity (via a cable well)

CODE	PRICE
SY4DIP-STD	Included





## Mast:

4x  USB 3.0 for PC

4x  HDMI

1x  13A socket

 HDMI switcher

 Infrared sensor + remote

## Standard options are:

1x HDMI input available for wireless display device or on-board PC

## Cable well:

Connections in the cable well:

3x  HDMI

1x  Mini Display Port (DP)

Connections in the mast:

1x  13A socket

4x  USB 3.0 for PC

 HDMI switcher

 Infrared sensor + remote

# BESPOKE DATA INTERFACE PLATES

If you have specific connectivity requirements for your SYNERGY, we offer a bespoke service to meet them. Additionally, we can customise labels to match your branding with our in-house service.

CODE	PRICE
SY4DIP-SP	£385



## Make it your own!

Mix & match to create your own solution:

- HDMI
- MiniDP
- Wireless displays
- USB 3.0
- 13A socket

We also accommodate international power & data inputs



## Integrate your control panel

As we manufacture **ALL** of our SYNERGY solutions in-house, we are able to integrate a wide range of control panels into the mast: (Extron, Crestron, AMX etc.)

## A blank canvas...

We can integrate virtually anything into our SYNERGY worktops such as cable retractors, microphones, writing surface inlays etc. Let us know what you need and we will see what we can do to meet your requirements!

## Additional cost options...

Replace up to 4 of the standard cable well connections with the following:



### USB Type C

DIP-UG-USBC	+£112 uplift (each)
-------------	---------------------



### Lightning (+ charge)

Includes original Apple adapter

DIP-UG-LC	+£286 uplift (each)
-----------	---------------------

# UNITY ROE

UNITY is a conference/meeting table which facilitates integrated technology.

Plug and play connectivity and power points are integrated into the centre of the table, enabling the user to connect and utilise supporting technology in the room and provides charging for their personal devices.

QUAD, BLADE, PLECTRUM, OVAL and CIRCULAR standard shapes available or may be customised to suit your specific requirements.



**Customisable worktop**  
Spine cable apertures anywhere along the spine



**Tamper proof**  
Complete internal cable management system



**Easy cable access**  
Removable/lockable panels for easy access to cabling



Model | **Fixed height** | **Height adjustable** | **Folding (POA)**

INCLUDED	
Choice of standard paint & worktop finishes	pg 89

ADDITIONAL COST (See all accessories on pg 59)	
Non-standard paint & worktop finishes	pg 89
'Shark-nose' worktop edge	pg 92
Desktop machining	pg 33
Bespoke connectivity	pg 54

MEASUREMENTS			
Worktop height (mm)	730 / 990	740 - 1000	730

## We offer a worktop for every requirement...

	NAME	MODEL	CODE	PRICE	CODE (HA)	PRICE
	<b>Quad</b> Classic shape ideal for face-to-face meetings.	4-seat	UY3QD04	£3,096	UY3QD04-HA	£4,828
		5-seat	UY3QD05	£3,256	UY3QD05-HA	£4,989
		6-seat	UY3QD06	£3,256	UY3QD06-HA	£4,989
		8-seat	UY3QD08	£4,061	UY3QD08-HA	£5,792
		10-seat	UY3QD10	£4,301	UY3QD10-HA	£6,033
		12-seat	UY3QD12	£4,664	UY3QD12-HA	£6,396
		14-seat	UY3QD14	£8,963	UY3QD14-HA	£10,094
		16-seat	UY3QD16	£9,971	UY3QD16-HA	£11,702
	20-seat	UY3QD20	£11,178	UY3QD20-HA	£12,909	
	<b>Blade</b> Encourages more focus towards the screen.	4-seat	UY3BE04	£3,096	UY3BE04-HA	£4,828
		5-seat	UY3BE05	£3,256	UY3BE05-HA	£4,989
		6-seat	UY3BE06	£3,256	UY3BE06-HA	£4,989
		8-seat	UY3BE08	£4,061	UY3BE08-HA	£5,792
		10-seat	UY3BE10	£4,301	UY3BE10-HA	£6,033
		12-seat	UY3BE12	£4,664	UY3BE12-HA	£6,396
		14-seat	UY3BE14	£8,963	UY3BE14-HA	£10,094
		16-seat	UY3BE16	£9,971	UY3BE16-HA	£11,702
	20-seat	UY3BE20	£11,178	UY3BE20-HA	£12,909	
	<b>Plectrum</b> Ergonomically designed & promotes group focus.	6-seat	UY3PM06	£3,256	UY3PM06-HA	£4,989
		9-seat	UY3PM09	£4,301	UY3PM09-HA	£6,033

## Bespoke options available...

We can customise your UNITY to meet your specific needs. If you have a particular shape or requirement in mind, please get in touch with our team to discuss the possibilities available.



# FOCUS POD ROE

Focus was designed to adapt and enhance the ever-changing workspace. This is a collaborative solution that can be placed in an open plan area to create an instant meeting space for a small group of people.

These booths, incorporating pod seating, help limit external office noise, encouraging collaboration between users by creating confidential meeting spaces with effective acoustics.

This unit has been designed with a collaborative table fixed to the sleek media unit which features an encapsulated screen. Focus allows people to collaborate, develop and share work seamlessly.



made to measure  
for your screen

Collaborative table accessories - pg 59



Model	4-seat		6-seat	
	42"	55"	42"	55"
Code	F42PC04-730	F55PC04-730	F42PC06-730	F55PC06-730
Price	£12,793	£13,205	£16,081	£16,493

### INCLUDED

Choice of standard paint & worktop finishes	pg 89
Pod seating (Fence) POD-GP2	pg 58

### ADDITIONAL COST (See all accessories on pg 59)

Non-standard paint & worktop finishes	pg 89
'Shark nose' worktop edge	pg 90
Desktop machining	pg 33
Data interface plate (F-DIP)	✓
Illuminated branding Above screen	✓ (pg 7)

### MEASUREMENTS (with pod seating)

Width (mm)	2643	3230	2700	3230
Depth (mm)	1625	1800	2470	2470
Pod height (mm)	1590	1755	1590	1755
Worktop height (mm)	730	730	730	730
Weight (kg)	170	180	210	220

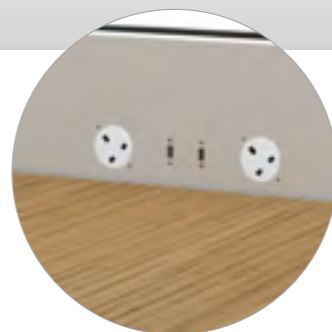

### Data interface plate

- Choice of:
- HDMI
  - USB
  - 13A power
  - Aperture for a control panel
  - Cut out for camera or sound bar











Internal cable management system

## We offer a wide range of seating options...

	NAME	MODEL	CODE	PRICE
	<b>Fence</b>	2-seat sofa	FXXPC04-730-POD-GP2	Included
	- Group 2 fabric - Other groups available POA - Price on pg 53 includes 2x Fence 2-seat <u>or</u> 3-seat sofas	3-seat sofa	FXXPC06-730-POD-GP2	Included
	<b>Plato</b>	2-seat sofa	-	POA
	- Group 2 fabric - Other groups available POA	3-seat sofa	-	POA
	<b>Zeno</b>	2-seat sofa	-	POA
	- Group 2 fabric - Other groups available POA	3-seat sofa	-	POA
	<b>Solon</b>	2-seat sofa	-	POA
	- Group 2 fabric - Other groups available POA	3-seat sofa	-	POA



# COLLABORATIVE TABLE ACCESSORIES

In addition to the items below, there is a large range of other accessories that have been specifically created for project requirements. Too numerous to list, we would be delighted to understand what you are looking to achieve. We may already have a solution designed to suit...





NAME	DESCRIPTION	CODE	PRICE	
	Cable well mounted into the centre of the worktop	SY4-CW	Included	
	With brush strips	SY4-CW002B	£54	
	With brush strips & cover plate	SY4-CW002BF	£109	
         	Power Options Standard colours: Black, grey & white *Other colours available on longer lead time	Single socket + 2x USB (charge) <span style="border: 1px solid black; padding: 0 2px;">S</span> 2 x 13A <span style="border: 1px solid black; padding: 0 2px;">S</span> 2 x 13A + 2x USB (charge) <span style="border: 1px solid black; padding: 0 2px;">S</span> 3 x 13A 3 x 13A + 4x USB (charge) 4 x 13A 4 x 13A + 4x USB (charge) 6 x 13A	PDM41C-1-2UC (Circular) <span style="border: 1px solid black; padding: 0 2px;">S</span> PDM05F-2 <span style="border: 1px solid black; padding: 0 2px;">S</span> PDM05F-2-2UC <span style="border: 1px solid black; padding: 0 2px;">S</span> PDM05F-3 PDM05F-3-4UC PDM05F-4 PDM05F-4-4UC PDM05F-6	£130 £103 £179 £134 £250 £193 £308 £204
	AirCharge station	AIRCHARGE	£165	
	Pluto	PDM31T	Prices from £216	
	Adjustable PC Cradle	Small ( <b>MAX</b> PC dimensions): 86-131mm(W) x 398mm(D) x 280-455mm(H)	240Z2	Included
		Large ( <b>MAX</b> PC dimensions): 145-220mm(W) x 460mm(D) x 325-500mm(H)	240Z3	
	Secure PC Cage	Made-to-measure	318Z	Included

made to measure to your PC

S = Available from stock

NAME	DESCRIPTION	CODE	PRICE	
	Crestron AirMedia	AIRMEDIA	£172	
	WePresent	WEPRESENT	£172	
	Clickshare	CLICKSHARE	£172	
	Echo Dot Housing	Secure enclosure for the Amazon Echo Dot.	100-739	£119
<div style="border: 1px solid #ccc; padding: 5px; display: inline-block;">Similar housings can be supplied (i.e. Google Home Mini)</div>				

## SYNERGY only

	Screen Mount Upgrades	Upgrade to two screens on your SYNERGY mast <b>JUPITER 01/PBL Up to 400x400 VESA</b> <b>JUPITER 02/PBL Up to 800x400 VESA</b>	JUPITER01/2-PBL-UPGRADE	£131
		Larger screens (single) <b>Up to 800x600 VESA</b>	JUPITER03-PBL	£142
	Under desk rack unit	8U rack	100-377-8U	£934
		10U rack	100-377-10U	£996
		12U rack	100-377-12U	£1,060
	Extended neck (Standard is 300mm)	500mm	SY4XXXX-N05	£347
		1000mm	SY4XXXX-N10	£692
<div style="border: 1px solid #ccc; padding: 5px; display: inline-block;">Other lengths available, please ask for guidance.</div>				
	Screen Shroud	Shroud for 42" screen	100-478-42	£355
		Shroud for 55" screen	100-478-55	£355
		Additional vinyl branding	NBRAND	+ £150
	Camera / Sound Bar Bracket	Made-to-measure for your specific camera or sound bar model Please specify above or below the screen.	100-594	£250



# Screen Trolleys & Stands

TOP-TEC have designed a range of mobile, static and wall mounted display solutions that can be fully integrated with AV and IT equipment.

Our screen trolleys provide the ideal solution for managing and supporting multi-media equipment, able to mount the majority of large screens and facilitate the seamless integration of AV/IT equipment.

Whether it's enhancing your corporate identity, providing wayfinders for visitors or providing an interactive, engaging meeting solution, our screen stands offer a simple, but powerful way to display information in focused areas.



## Make it your own!

We can meet any colour option requirements to match your branding.



## Tamper proof solution

Keep cables concealed, eliminating any potential tampering.



## Facilitates seamless AV/IT integration

Complete cable management creates an 'all-in-one' solution.

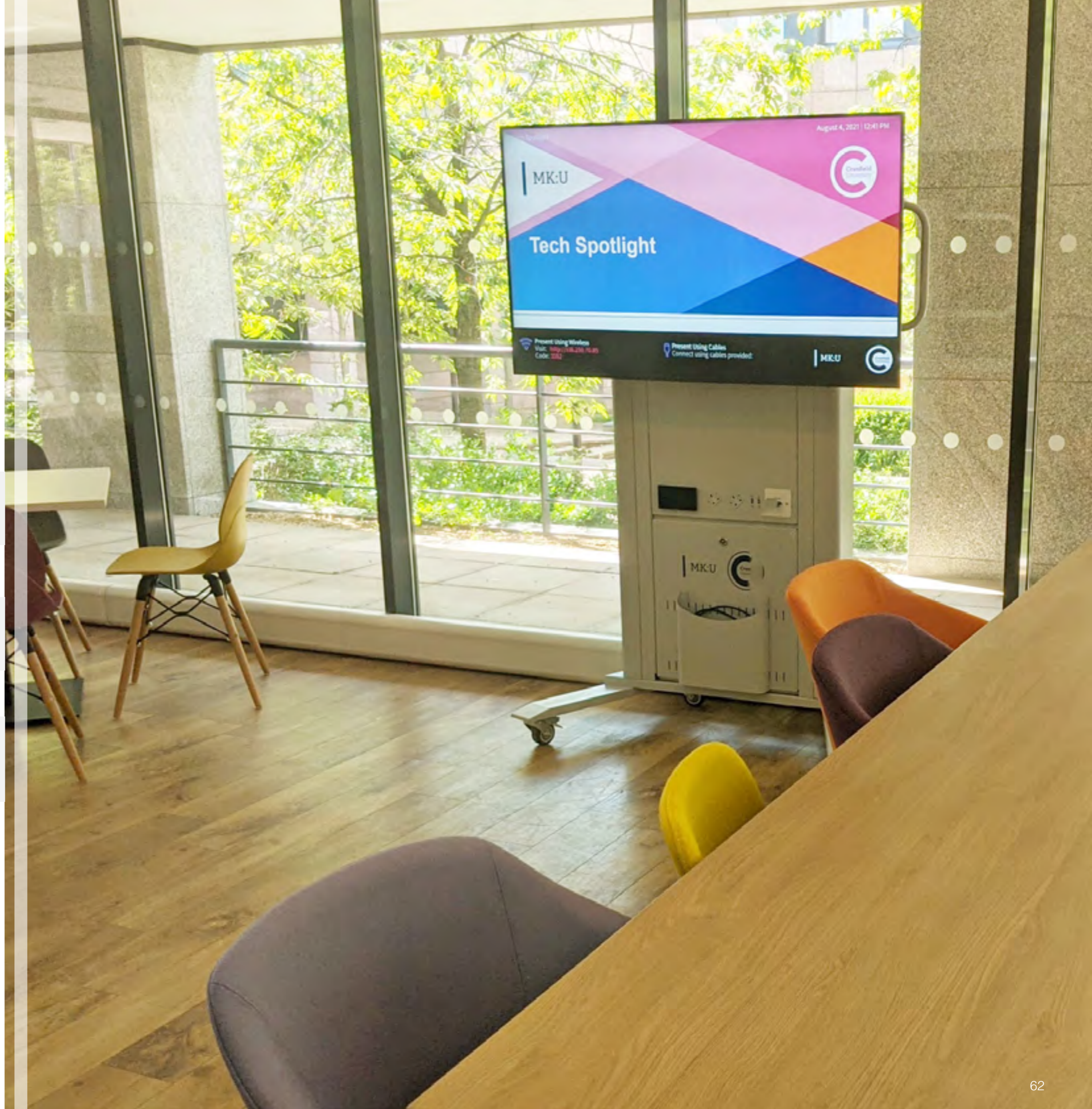

# RISE <sup>D</sup>

Create flexible learning environments



**Ideal for flexible learning**  
Choose to use the screen up or concealed when not in use..



**2x 1U rack space**  
Allows rack mounted equipment to be integrated behind the screen and in the lower section of the unit.



**AV/IT integration**  
Complete internal cable management creates an 'all-in-one' solution.



Rise is a flexible learning solution designed to give the user the ability to rearrange classrooms on the fly and create different learning environments to suit their teaching style on the day.

The unit can be used as a traditional display while the screen is raised and can also be partnered with flexible desks for collaborative group work. The screen can be retracted when it is not needed, providing clear line of sight for students.

2x 1U top loading rack space    Screen(s) not included



Screen rises from the base

# RISE + ARC

Your perfect agile learning package

suitable for 42-50"

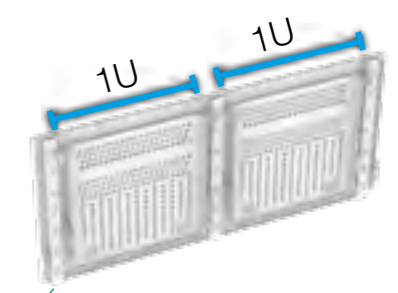

2x 1U top loading rack space. Can be removed from unit to populate rack.

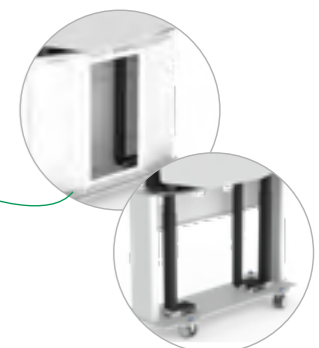

Removable front & rear panels for easy equipment access

Nesting design for efficient storage



**Simple screen deployment**  
- High quality castors  
- Can be nested when not in use  
- Quickly & easily create learning spaces

**Flexible learning solution**  
- Combines with our Arc tables for the perfect flexible learning package

NAME	CODE	PRICE
Rise	REXX-SR-SM	£3,405
Product dimensions: 1360mm(W) x 520mm(D) x 1003mm(H) Screen raised: 1620mm(H) MAX screen size: 1175mm(W) x 100mm(D) x 650mm(H) VESA (up to): 400x400		
<b>INCLUDED</b>		
Standard paint finishes	pg 89	
4x castors (2x braked)	✓	
Front & rear removable panels	✓	
Handles	✓ (Optional Extra)	
On-board 4-gang power	✓	
<b>ADDITIONAL COST</b>		
Non-standard paint finishes	pg 89	
Vinyl or printed branding	pg 7	
Front input plate HDMI / USB / 13A / Aperture or cut out for control panel, camera, sound bar	£385	
Arc Tilting Tables (4 & 6-seat Blade)	from £847 - £1,078	



Screen can be raised and partnered with tables for IT based group work

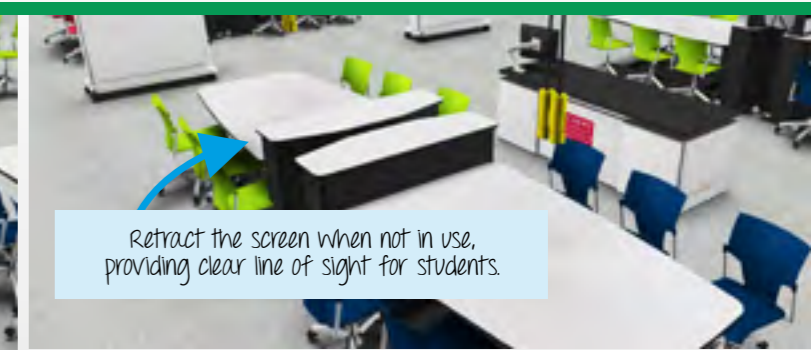

Retract the screen when not in use, providing clear line of sight for students.



Can be stored away when not in use so that the space can be used for other activities

# CoACT<sup>D</sup>

Ideal for multi-purpose spaces, CoACT is a flexible display solution that facilitates different learning styles within the same space, transitioning from whiteboard to screen display in a matter of seconds.

CoACT is made-to-measure to your screen model, and its effective internal cable management system alongside seamless AV/IT integration result in a stylish 'all-in-one' solution.



made to measure for your screen

Screen(s) not included

On-board tilting rack space



Model Code Price	Screen only		Screen + whiteboard	
	55"	65"	55"	65"
	CT55L	CT65L	CT55L-WB	CT65L-WB
	£4,233	£4,517	£5,401	£5,526
Internal rack space	4U full / 8U half (top loaded - vertical) 7U full / 14U half (front loaded - 220mm deep)			
<b>INCLUDED</b>				
Standard paint finishes	pg 89		pg 89	
4x castors (2x braked)	✓		✓	
Input plate on side of unit 1x USB charge + 1x 13A	✓		✓	
<b>ADDITIONAL COST</b>				
Non-standard paint finishes	pg 89 (inc. two-tone)		pg 89 (inc. two-tone)	
Vinyl or printed branding	pg 7		pg 7	
Illuminated branding	£436 (pg 7)		£436 (pg 7)	
Equipment shelf	✓		✓	
Pen tray	✗		£115	
Front input plate HDMI / USB / 13A / Aperture or cut out for control panel, camera, sound bar	✓		✓	
<b>MEASUREMENTS</b>				
Width (mm)	1500	1720	1500	1720
Depth (mm)	520	520	520	520
Height (mm)	1954	1954	1954	1954
Weight (kg)	141	162	144	165
MAX screen dims. (WxDxH)	1325 x 860 x 100	1540 x 910 x 100	1325 x 860 x 100	1540 x 910 x 100
MAX screen viewing area (WxH)	1225 x 697	1445 x 820	1225 x 697	1445 x 820

# SWITCH 90<sup>D</sup>

The SWITCH 90 takes interactive screens to the next level as they electronically move through 90° to become a touch screen table. Each unit is electrically height adjustable to suit all user height preferences. We also have a 45° model alongside a 70° ideal for the Microsoft Surface Hub 2.

The mobile trolley also features secure storage space beneath the screen and can be configured to your requirements with customisable connectivity inputs and a range of colour options.

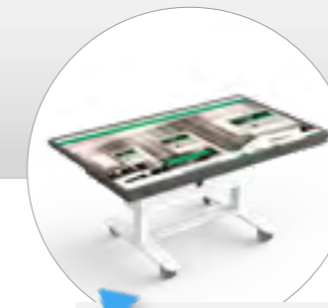

suitable for 55-75"

Screen turns 90° into a flat surface

Screen(s) not included



45°

SWITCH 45  
(up to 45° tilt)

Code: SW45-HA  
Price: £3,398

70°

SWITCH 70  
(up to 70° tilt)

Code: SW70-HA  
Price: £3,398

90°

SWITCH 90  
(up to 90° tilt)

Code: SW90-HA  
Price: £3,398

Model Code Price	SWITCH 45 (up to 45° tilt)	SWITCH 70 (up to 70° tilt)	SWITCH 90 (up to 90° tilt)
	SW45-HA	SW70-HA	SW90-HA
	£3,398	£3,398	£3,398
<b>INCLUDED</b>			
Standard paint finishes	pg 89		
Storage space for PC	✓		
Screen mount (VESA)	800x500		
<b>ADDITIONAL COST</b>			
Non-standard paint finishes	pg 89		
Bespoke connectivity inputs HDMI / USB / Control panel aperture	✓		
Laptop shelf + arm	✓		
<b>MEASUREMENTS</b>			
Width (mm)	1100	1100	1100
Depth (mm)	885	885	885
Height (at 90° position) (mm)	-	-	1102-1762
Height (at flat position) (mm)	-	-	761-1421
Weight (kg)	85	85	85
MAX screen weight (kg)	90kg (inc. screen in flat position + peripherals)		

● Please note: Smaller size screen models available on request.



Secure storage space for PC



Bespoke connectivity options



Laptop shelf + arm

# SPIRE TROLLEY



The SPIRE TROLLEY offers the ideal solution for open plan and agile learning spaces and is the perfect fully integrated solution for use as both a teaching aid and digital signage.

Our SPIRE TROLLEY is available with 'Gravity' height adjustment, allowing the screen to effortlessly rise and fall manually by the user.



Equality Act compliance

Screen(s) not included



8U rack space (not available on Gravity HA version)



Removable/lockable panels for maintenance



Screen shroud (+ vinyl branding)

Model	Trolley	Trolley (Gravity HA)
Code	SPTY-JLXX	SPTY-ZGHA-JLXX
Price	£2,947	£4,032

## INCLUDED

	pg 89	pg 89
Standard paint finishes	pg 89	pg 89
USFF PC enclosure	✓ (Optional extra)	X
Screen mount (VESA)	01 - 400x400	01 - 400x400
JUPITER LITE 01 (padlock)	Suited push button locks POA	Suited push button locks POA

## ADDITIONAL COST

	pg 89 (inc. two-tone)	pg 89 (inc. two-tone)
Larger screen mount (VESA)	£21 (02 - 700x400)	£21 (02 - 700x400)
JUPITER LITE 02 (padlock)	Suited push button locks POA	Suited push button locks POA
Handles	£214	£214
Screen shroud	£355	£355
Vinyl branding	£150 (pg 7)	£150 (pg 7)
Bespoke connectivity inputs	£385	£385
HDMI / USB / Control panel aperture		
Sound bar / camera shelf	£250	£250
8U rack	£934	X
Hanging data interface plate	£457	£457

## MEASUREMENTS

Width (mm)	945	945
Depth (mm)	710	710
Height (mm)	1960	1960
Weight (kg)	~50	~50
Suitable for	42"+	50"+

# SPIRE



SPiRE is available as wall-mounted and floor-supported configurations, designed to be the ideal lecturer's station for smaller rooms. Each unit is adaptable to any requirements the user may have.

It features a tamper proof security cage in the centre of the product able to house a PC, with concealed internal cable management in the mast.

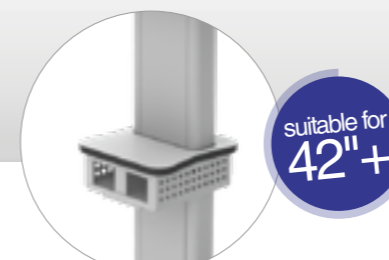

Optional Extra USFF PC enclosure 300mm(W) x 300mm(D) x 67mm(H)

suitable for 42"+

Screen(s) not included



Model	Wall Mount	Floor-to-wall Mount
Code	SPWM01-JLXX	SPFM01-JLXX
Price	£2,354	£2,555

## INCLUDED

	pg 89	pg 89
Standard paint finishes	pg 89	pg 89
USFF PC enclosure	✓	✓ (Optional extra)
Screen mount (VESA)	01 - 400x400	01 - 400x400
JUPITER LITE 01 (padlock)	Suited push button lock options (POA)	Suited push button lock options (POA)

## ADDITIONAL COST

	pg 89 (inc. two-tone)	pg 89 (inc. two-tone)
Larger screen mount (VESA)	£21 (02 - 700x400)	£21 (02 - 700x400)
JUPITER LITE 02 (padlock)	Suited push button lock options (POA)	Suited push button lock options (POA)
Bespoke connectivity inputs	£385	£385
HDMI / USB / Control panel aperture		
Vinyl branding	£150 (pg 7)	£150 (pg 7)
Sound bar / camera shelf	£250	£250
Keyboard shelf	POA	POA
Hanging data interface plate	£457	£457

## MEASUREMENTS

Width (mm)	395	395
Depth (mm)	400	423
Height (mm)	1330	1920
Weight (kg)	37	50

# ADAPT <sup>D</sup>

ADAPT your space for teaching. The ADAPT trolley features a strong yet slim steel build, screen mount and secure space for a PC. Fitted with high quality castors and a universal screen mount, it is designed to nest within other units for tidy unobtrusive storage.

The ADAPT is easy to deploy, enables room flexibility and the ability to quickly supply functionality to a room where the built in systems have failed

It comes with 3 x 2U vertical racks on each side with a removable aperture cover for PC access. The keyboard pocket can be moved/removed depending on user preference.

suitable for 42" +

Screen(s) not included



**ADAPT**  
ACT-165  
£2,778

Rack space: 3x 2U vertical (on each side)

## INCLUDED

Standard paint finishes	pg 89
Keyboard pocket	✓ (Optional Extra)
Handles	✓
Screen mount (VESA) JUPITER01-PBL or JUPITER02-PBL	01 - 400x400 02 - 700x400

## ADDITIONAL COST

Non-standard paint finishes	pg 89
Vinyl or printed branding	pg 7
Larger screen mount (VESA) JUPITER03-PBL	£142 03 - 800x600
Bespoke connectivity inputs HDMI / USB / Control panel aperture	£385
Angled data interface plate	£385
Hanging data interface plate	£457
Sound bar / camera shelf	£250

## MEASUREMENTS

Width (mm)	1325
Depth (mm)	708
Height (mm)	1666
Weight (kg)	75



3x 2U rack space on each side



Removable/lockable panels for maintenance



Bespoke aperture for your specific PC model

# ADAPT HA <sup>D</sup>

ADAPT is available with either electric or manual 'Gravity' height adjustment.

Electric height adjustment allows the screen to be adjusted at the push of a button, whilst 'Gravity' height adjustment allows the screen to be effortlessly raised and lowered manually by the user.

ADAPT HA also enables Equality Act compliance within any learning space, accommodating all user height requirements.

Equality Act compliance suitable for 42" +

Screen(s) not included



**ADAPT HA (Electric)**  
ACT-HA  
£3,483

Rack space: X

## INCLUDED

Standard paint finishes	pg 89	pg 89
Keyboard pocket	✓ (Optional Extra)	✓ (Optional Extra)
Handles	✓	✓
Screen mount (VESA) JUPITER01-PBL or JUPITER02-PBL	01 - 400x400 02 - 700x400	01 - 400x400 02 - 700x400

## ADDITIONAL COST

Non-standard paint finishes	pg 89	pg 89
Vinyl or printed branding	pg 7	pg 7
Larger screen mount (VESA) JUPITER03-PBL	£142 03 - 800x600	£142 03 - 800x600
Bespoke connectivity inputs HDMI / USB / Control panel aperture	£385	£385
Angled data interface plate	X	X
Hanging data interface plate	£457	£457
Sound bar / camera shelf	£250	£250

## MEASUREMENTS

Width (mm)	1325	1325
Depth (mm)	708	708
Height (mm)	1666	1666
Weight (kg)	~100	-



**ADAPT HA (Gravity / Manual)**  
ACT-ZGHA  
£3,864

Rack space: 3x 2U vertical (on each side)

# LEVITATOR HA

LEVITATOR HA is an electrically height-adjustable trolley suitable for mounting and securing large screens.

Ideal for classrooms, boardrooms, reception and office environments, LEVITATOR HA offers an ideal solution for the easy deployment of screens.

Each unit features a lockable storage space behind the screen to securely enclose your AV equipment and conceal the screen locking bar.



suitable for 55" +

Screen(s) not included



**LEVITATOR HA**  
LR2T  
£1,540

Model  
Code  
Price

### INCLUDED

Black metalwork finish	✓
Screen mount (VESA)	800x600
4x 4" castors (2x lockable)	✓
Secure storage space	✓

### ADDITIONAL COST

Hook-on laptop shelf	£130
White metalwork finish	£242
Sound bar / camera shelf	£250
Plastic screen shroud (black)	£255
Vinyl branding	pg 7

### MEASUREMENTS

Width (mm)	1042
Depth (mm)	719
Height (mm)	1104-1734
Weight (kg)	55
<b>MAX screen weight (kg)</b>	<b>80kg</b>

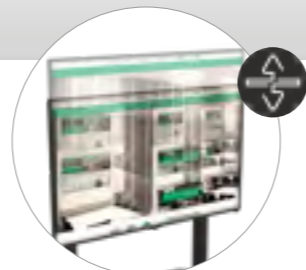

Adjust to your preferred screen height



Lockable storage space behind the screen



Hook-on laptop shelf



Screen shroud option + vinyl branding

# DISCOVERY

Discovery encourages collaboration in workplace and educational environments, allowing users to create instant meeting and working spaces in any open plan area.

Each unit features 10U full width / half depth (horizontal) / 4U full width (vertical) rack space for AV/IT equipment and storage for a PC, creating the perfect all-one-solution.



suitable for 55" +

Screen(s) not included



Model Code	<b>Single Screen</b> DISC2-TXXHA	<b>Dual Screen</b> DISC2-TXXHAT
Price	£2,961	£3,365

Internal rack space	4U full width (vertical) 10U half depth (horizontal)	
---------------------	---	--

### INCLUDED

Standard paint finishes	pg 89	pg 89
PC storage	✓	✓
Screen mount (VESA)	600x400	700x400 per screen

### ADDITIONAL COST

Non-standard paint finishes	pg 89	pg 89
Keyboard shelf	£505	£505
Vinyl or printed branding	pg 7	pg 7
Bespoke connectivity inputs HDMI / USB / Control panel aperture	£385	£385
Sound bar / camera shelf	£250	£250
Hanging data interface plate	£457	£457

### MEASUREMENTS

Width (mm)	810	1810
Depth (mm)	1000	1000
Height (mm)	1870	1870
Weight (kg)	140	270
<b>MAX screen weight (kg)</b>	<b>130kg</b>	<i>Please ask for guidance</i>

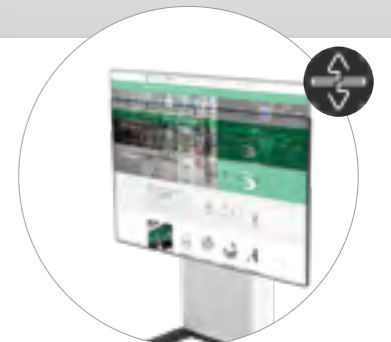

Electrically height adjustable

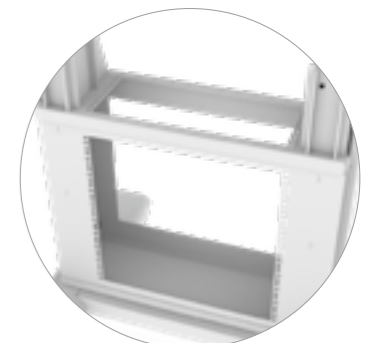

Internal rack space



Camera and sound bar options available

# NOVA <sup>D</sup>

Designed with security, fast installation and affordability in mind, Nova is a range of screen trolley, floor-mount and wall-mounted solutions that can securely mount screens and quickly supply functionality to a variety of meeting and learning spaces.

All cables are concealed within the mast alongside space for a small PC. The trolley version can also be supplied with a hook-on equipment shelf for a keyboard and mouse or laptop resulting in an 'all-in-one' cost effective PC on wheels solution.

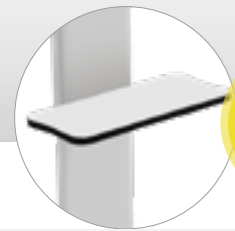

10-day lead-time

Screen(s) not included

Hook-on equipment shelf  
610mm(W) x 300mm(D)



Model	Wall/Floor Mount	Floor Mount	*Trolley	Trolley (extended base)
Code	NAWF-18	NAS-18	NATN-18	NATW-18
Price	£930	£984	£1,037	£1,058

### INCLUDED

Standard paint finishes	pg 89	pg 89	pg 89	pg 89
Removable back panel (+ push button lock)	X	✓	✓	✓
Screen mount (VESA) JUPITER LITE 01	01 - 400x400	01 - 400x400	01 - 400x400	01 - 400x400
3" castors	X	X	✓	✓

### ADDITIONAL COST

Non-standard paint finishes	pg 89	pg 89	pg 89	pg 89
Hook on equipment shelf	X	£191	£191	£191
Larger screen mount (VESA) JUPITER LITE 02	£21 (02 - 700x400)	£21 (02 - 700x400)	£21 (02 - 700x400)	£21 (02 - 700x400)

### MEASUREMENTS

Width (mm)	395	395	884	1184
Depth (mm)	400	423	710	710
Height (mm)	1718	1718	1836	1836
Weight (kg)	37	50	65	65
MAX screen weight (kg)	60kg	60kg	60kg	60kg
Suitable for	42" - 65"	42" - 65"	42" - 65"	65"+



Black metal finish / white compact laminate shelf / other finishes available on 10-day lead-time

# DS STAND <sup>D</sup>

The DIGITAL SIGNAGE STAND is an elegant effective housing for both screens, PCs and other AV/IT equipment. The free standing screen enclosures can be finished to suit any brand style, including illuminated, printed or vinyl branding.

Designed to be used for displays in meeting and public areas or as internal information points, these stands allow for large screens to be strategically placed wherever they may have the most impact.

Ideal for use in meeting rooms where tamper proof installation is required.



Screen(s) not included



Model	55"		65"		Up to 95"	Up to 65" (Double Sided)	
	Landscape	Portrait	Landscape	Portrait		Landscape	Portrait
Code	DDC55/L	DDC55/P	DDC65/L	DDC55/P	DDC95/L	DDCXX/BB/L	DDCXX/BB/P
Price	£3,526		£3,809		£5,768	POA	

### INCLUDED

Standard paint finishes	pg 89
Internal fixing points	✓
IR extender	✓ (Optional Extra)

### ADDITIONAL COST

Non-standard paint finishes	pg 89
Illuminated branding	£436 (pg 7)
Vinyl or printed branding	pg 7
Equipment shelf	£214
Connectivity inputs HDMI / USB / 13A / Aperture or cut out for control panel, camera, sound bar	£385

### MEASUREMENTS (Standard)

Footprint (mm)	1513 x 415	1003 x 415	1781 x 415	1113 x 415	2447 x 515	-
Width (mm)	1300	790	1520	920	2190	-
Depth (mm)	415	415	415	415	515	-
Height (mm)	1740	1750	1865	1850	2235	-
Weight (kg)	104	100	120	110	180	-

# AVI TOWER <sup>D</sup>

A superb aesthetic solution for any meeting room, corridor or public area.

The AVI Tower has been designed to minimise the installation profile whilst providing significant rack / PC storage within its frame. The reinforced tower will support heavier touch screens up to 127kg.

Each unit is supplied in 1m vertical modules, featuring 2x 2U of rack space on each side.



suitable for 42"+

Screen(s) not included

# CVC STAND <sup>D</sup>

Positioned a short distance from the end of a meeting table and typically configured for wireless display broadcasting, the CVC Stand is perfect for touch screen applications. The video conferencing solution is ideal for narrow rooms where two screens are required.

The unit is mounted on castors concealed under the base which allow easy positioning and relocation. Available with our universal screen mount for 400x400 VESA typically suiting 55" or 65" screens. Larger mounts available.

An internal 5U top loaded rack mounted on drawer slides inside the unit, allowing you to integrate your AV equipment with easy access for engineers.



suitable for 55-65"

Screen(s) not included

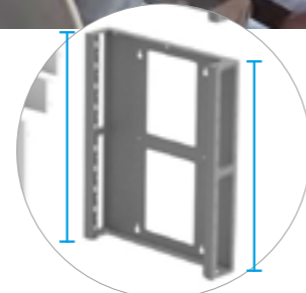

2x 2U rack modules on each side of unit



Removable/lockable panels for maintenance



Model	Standard	Reinforced	Gravity HA
Code	AVI-A1-400	AVI-R1-400	AVI-R1-400-ZGHA
Price	£1,439	£1,587	POA

Internal rack space	2x 2U rack modules on each side of unit		
---------------------	---	--	--

### INCLUDED

	Standard	Reinforced	Gravity HA
Standard paint finishes	pg 89	pg 89	pg 89
Screen mount (VESA) JUPITER01-PBL or JUPITER02-PBL	01 - 400x400 02 - 700x400	X	X
Non-secure screen mount (VESA)	X	X	800x400

### ADDITIONAL COST

	Standard	Reinforced	Gravity HA
Non-standard paint finishes	pg 89	pg 89	pg 89
Vinyl or printed branding	pg 7	pg 7	pg 7
Larger screen mount (VESA) JUPITER03-PBL	£142 03 - 800x600	X	X
Extender module (+500mm)	£505	£505	£505
Sound bar / camera shelf	£250	£250	£250
Bespoke connectivity inputs HDMI / USB / Control panel aperture	£386	£386	£386

### MEASUREMENTS

	Standard	Reinforced	Gravity HA
Width (mm)	750	750	750
Depth (mm)	160	160	160
Height (mm)	2000 (2PCS x1000)	2000 (2PCS x1000)	2000 (2PCS x1000)
Weight (kg)	50	≤ 120	≤ 120
<b>MAX</b> screen weight (kg)	60kg	127kg	95kg

### Gravity height adjustment

Screen weight:	BB-400-40
23kg – 42kg	BB-400-70
41kg – 69kg	BB-400-90
66kg – 95kg	

Model	Single Screen	Dual Screen
Code - 55" screen	CVC-1-55	CVC-2-55
Price	£3,464	£3,809
Code - 65" screen	CVC-1-65	CVC-2-65
Price	£3,809	£4,155

Internal rack space	5U (top loaded)	
---------------------	-----------------	--

### INCLUDED

Standard paint finishes	pg 89
-------------------------	-------

### ADDITIONAL COST

	Standard	Dual Screen
Non-standard paint finishes	pg 89	pg 89
Vinyl branding	pg 7	pg 7
Heavy duty castors	✓	✓

### MEASUREMENTS

	Single Screen	Dual Screen
Width (mm)	1200	1200
Depth (mm)	500	500
Height (mm)	1300	2150
Weight (kg)	~70	~100



# WAYFINDER <sup>D</sup>

Our WAYFINDERS enable screens to be securely placed in any open plan area, allowing information to be displayed to students or employees or for the deployment of touch screens for map and way-finding purposes.

The free standing units are ideal for areas accessible to the general public and large groups of people such as reception spaces and library areas. Internal use only.

Available in single and dual screen configurations, the kiosks are customisable to your requirements featuring a range of standard colour finishes and vinyl corporate branding.



made to measure for your screen

suitable for 40-55"

Screen(s) not included



Model	Single Screen (Landscape)	Dual Screen (Landscape)	Single Screen (Portrait)
Code	WR1L	WR2L	WR1P
Price	£3,528	£4,294	£3,528

### INCLUDED

Standard paint finishes	pg 89
-------------------------	-------

### ADDITIONAL COST

Non-standard paint finishes	pg 89
Vinyl branding	pg 7

### MEASUREMENTS

	Single Screen (Landscape)	Dual Screen (Landscape)	Single Screen (Portrait)
Width (mm)	1150	1150	~590
Depth (mm)	644	1274	~761
Height (mm)	1185	1174	~1704
Weight (kg)	60	100	-

# WAYFINDER MINI <sup>D</sup>

The WAYFINDER MINI/MICRO offers a stylish and elegant solution for mounting screens, ideal for reception spaces in both education and corporate environments. These units are ideal for use as sign-in or registration points, allowing touch screens to be easily deployed in open plan areas.

Internal cable management, grommet holes and the option to run cabling through the bottom of the unit result in an all-in-one solution with minimal disruption to its surroundings.

Each unit can be customised to match your corporate identity with a range of standard colour finishes and vinyl branding options.



up to 32"

Screen(s) not included



Model	WAYFINDER NANO	WAYFINDER MINI
Code	WR1MN1010	WR1M1010
Price	£1,010	£1,010

### INCLUDED

Standard paint finishes	pg 89
Fixed screen mount (70°) (100x100 VESA)	✓
Floor fixings	✓

### ADDITIONAL COST

Non-standard paint finishes	pg 89
Vinyl or printed branding	pg 7
Tilting screen mount (40°-85°) (100x100 VESA)	£101
VESA adapter plate	POA
Bespoke connectivity inputs HDMI / USB / Control panel aperture	£385

### MEASUREMENTS

	Wayfinder Nano	Wayfinder Mini
Width (mm)	535	535
Depth (mm)	350	350
Height (mm)	800	1250
Weight (kg)	20	25



Optional tilting screen mount from 40°-85°



Removable back panel for easy maintenance



Can be fixed/bolted to the floor for added security

# Screen Brackets & Monitor Mounts

We supply a range of brackets and mounting kits for screens, monitors, tablet mounts and other accessories.

We offer a range of JUPITER screen mounts, ranging from universal screen mounts to extending screen mounts for all screen weights. These screen mounts are designed to accommodate the full range of different screen sizes.



# MONITOR & TABLET MOUNTS <sup>D</sup>

	NAME	MODEL	CODE	PRICE
	<b>ENDO72 (Chrome)</b>	Single monitor	ENDO72	£215
	- Chrome finish - Accommodates screens with 75mm or 100mm VESA centres - <b>Single:</b> up to 9.1kg	Single monitor (wall-mounted)	ENDO72W	£215
	<b>ENDO72 (White)</b>	Single monitor	ENDO72-WE	£215
	- White finish - Accommodates screens with 75mm or 100mm VESA centres - <b>Single:</b> up to 9.1kg			
	<b>ENDO82 (Chrome)</b>	Single monitor	ENDO82	£215
	- 80° tilt / 360° swivel / 90° rotation - Accommodates screens with 75mm or 100mm VESA centres - <b>Single:</b> up to 13.6kg	Single monitor (wall-mounted)	ENDO82W	£215
	<b>ENDO72/2</b>	Dual monitor (white)	ENDO-72/2-WE	£401
	- White or chrome finish - Accommodates screens with 75mm or 100mm VESA centres - <b>Dual:</b> up to 18.1kg	Dual monitor (chrome)	ENDO-72/2	£401
	<b>ENDO72/2 Dual Direct</b>	Dual monitor	ENDO72/2DD	£473
	- 2 screens attached to one arm - Accommodates screens with 75mm or 100mm VESA centres - <b>Dual:</b> up to 10kg			
Other ENDO monitor mounts available, please ask for guidance.				
	<b>Secure Monitor Bracket</b>	Tilt / 360° swivel	485-V2	£202
		Tilt / 360° swivel / height adjust	485-V3	£212
		Tilt / 360° swivel / height / focal length adjust	485-V4	£384
	<b>TABDISPLAY</b>	Fixed	TDHF	£193
	Made to measure for <b>ALL</b> tablets:	Rotating	TDHR	£235
	- iPad - Google Nexus - Microsoft Surface - Amazon Fire / Kindle - Samsung Galaxy	w/ ENDO82 monitor arm	TDHA82	£413



# SCREEN BRACKET KITS

	NAME	OPTIONS	CODE	PRICE	
	<b>JUPITER - Single Screen Mounting Kit</b>	<b>454x259 VESA</b>	<b>Secure</b>		
	Each kit includes the following:		0.5m pole	Y01A-05-SSL	£416
			1.0m pole	Y01A-10-SSL	£432
			1.5m pole	Y01A-15-SSL	£446
			2.0m pole	Y01A-20-SSL	£468
		<b>454x259 VESA</b>	<b>Non-secure</b>		
			0.5m pole	Y01A-05-SS	£372
			1.0m pole	Y01A-10-SS	£389
			1.5m pole	Y01A-15-SS	£406
			2.0m pole	Y01A-20-SS	£433
		<b>825x445 VESA</b>	<b>Secure</b>		
			0.5m pole	Y02A-05-SSL	£446
			1.0m pole	Y02A-10-SSL	£468
			1.5m pole	Y02A-15-SSL	£485
			2.0m pole	Y02A-20-SSL	£500
		<b>825x445 VESA</b>	<b>Non-secure</b>		
		0.5m pole	Y02A-05-SS	£416	
		1.0m pole	Y02A-10-SS	£432	
		1.5m pole	Y02A-15-SS	£446	
		2.0m pole	Y02A-20-SS	£468	

# SCREEN BRACKETS

	NAME	CODE	VESA (up to)	MAX SCREEN WEIGHT	PRICE
	<b>JUPITER 485-Z</b>	485-Z01 / 1A	454x259	80kg	£282
	<ul style="list-style-type: none"> <li>- More compact design</li> <li>- Increased 10° downwards tilt</li> <li>- Drill-resistant locks</li> <li>- Fully adjustable mounting arms</li> </ul>	485-Z02 / 2A	825x445	80kg	£319
		485-Z03	1000x400	80kg	£411
	<b>JUPITER 485-Y</b>	485-Y01 / 1A	454x259	80kg	£282
	<ul style="list-style-type: none"> <li>- 6° downwards tilt</li> <li>- Drill-resistant locks</li> <li>- Fully adjustable mounting arms</li> </ul>	485-Y02 / 2A	825x445	80kg	£319
		485-Y03	1000x400	80kg	£411
	<b>JUPITER PBL</b>	JUPITER01-PBL	400x400	125kg	£267
	<ul style="list-style-type: none"> <li>- Push button lock</li> <li>- Fully adjustable mounting arms</li> </ul>	JUPITER02-PBL	700x400	95kg	£267
		JUPITER03-PBL	800x600	100kg	£409
	<b>JUPITER LITE</b>	J-LITE01	400x400	125kg	£183
	<ul style="list-style-type: none"> <li>- Robust padlock</li> <li>- Fully adjustable mounting arms</li> </ul>	J-LITE02	700x400	95kg	£204
		J-LITE02 (Portrait)	400x600	120kg	£204

	NAME	CODE	VESA (up to)	MAX SCREEN WEIGHT	PRICE	
	<b>JUPITER DUAL SCREEN BRACKET</b>	JUPITER01/2-PBL	2x screen(W) 780mm based on 400mm(W) VESA mount	90kg total	£398	
	<ul style="list-style-type: none"> <li>- VESA (per screen) MAX</li> </ul>	JUPITER02/2-PBL	2x screen(W) 1140mm based on 400mm(W) VESA mount	165kg total	£398	
		JUPITER03/2-PBL	2x screen(W) 1400mm based on 600mm(W) VESA mount	135kg total	£528	
	<b>JUPITER SHUTTLE</b>	JUPITER-SHUTTLE-01	600x400	47kg	£273	
	<ul style="list-style-type: none"> <li>- Slide out plate for AV equipment accessible from both sides</li> <li>- 0° / 5° / 10° downwards tilt</li> <li>- Adjustable VESA mounting arms</li> <li>- All cables neatly concealed behind the screen</li> <li>- Robust padlock + locking bar</li> <li>- Push button lock versions available (-PBL)</li> </ul>	JUPITER-SHUTTLE-01-PBL	600x400	47kg	£380	
		<b>Compartment size: 01</b> - 680 x 291 x 60/80				
		JUPITER-SHUTTLE-02	800x400	70kg	£273	
		JUPITER-SHUTTLE-02-PBL	800x400	70kg	£380	
	<b>Compartment size: 02</b> - 880 x 291 x 60/80					
		JUPITER-SHUTTLE-03	800x600	55kg	£400	
		JUPITER-SHUTTLE-03-PBL	800x600	55kg	£514	
	<b>Compartment size: 03</b> - 880 x 491 x 60/80					
	<b>JUPITER SFF</b>	J02-SF02-X	500x500	-	£522	
	<ul style="list-style-type: none"> <li>- Integrated enclosure for SFF PC</li> <li>- Brackets available with 10° downwards tilt (POA)</li> <li>- Choice of left hand, right hand or 2x enclosures</li> </ul>	J02-SF02-LR	300x500	-	£651	
		J02-SF03-X	400x500	-	£522	
		J02-SF03-LR	100x500	-	£651	
	<b>SF02 enclosure size:</b> 55 x 225 x 190		J03-SF02-X	600x600	-	£644
	<b>SF03 enclosure size:</b> 55 x 335 x 190		J03-SF02-LR	400x600	-	£690
			J03-SF03-X	500x600	-	£644
			J03-SF03-LR	200x600	-	£690
		<b>JUPITER COMPACT</b>	J-VFM01	75x75 & 100x100	-	£109
		<ul style="list-style-type: none"> <li>- Robust padlock</li> </ul>				
		<b>Extending Screen Wall Bracket</b>	485-003	200x100 up to 600x400	36.3kg	£752
		<ul style="list-style-type: none"> <li>- Adapter bars available for 75 x 75 VESA screens</li> </ul>				
	<b>Monitor Wall Bracket</b>	Short	485U2WMS	75x75 & 100x100	-	£255
		Long	485U2WML	75x75 & 100x100	-	£255
		Extending	485U4WM	75x75 & 100x100	-	£446
	<b>Screen Bracket Adaptor</b>	Single	105-PB1	-	-	£87
	<ul style="list-style-type: none"> <li>- Attaches screen brackets to a 50mm column</li> <li>- Lockable (L) versions available</li> </ul>	Twin	105-PB1-L	-	-	£120
			105-PB2	-	-	£139
			105-PB2-L	-	-	£174
	<b>Protective Screen Cover</b>	JPCS / JPCL	-	-	From	£547
	<ul style="list-style-type: none"> <li>- Anti-shatter acrylic cover</li> <li>- Made-to-measure for each specific screen (32"-85")</li> <li>- Size and quantity dependant</li> </ul>					

# Projector Mounting Solutions RO



**Accommodates ALL major projector models**  
Manufactured in-house, we are able to produce mounts and cages that are exclusively tailored to specific projector types.



**Secure your equipment**  
Our solutions cover a range of security options from simple mounts to completely secure cages.





**Flexible design**  
All of our cages & mounts feature 360° rotation and 35° tilt and fit universally to our standard 50mm column.



Standard colours:  White (WE)  Dark Grey (GY)  Black (BK)

## MOUNTING KITS RO

	NAME	CODE		0.5m	1.0m	1.5m	2.0m
	<b>PLUTO SecurPLATE KIT</b>	SecurPlate01A	AVB-M1A	£269	£278	£295	£313
	Each kit includes: - 1x Standard ceiling plate (CP1) - 1x Standard column (105-SDC) - 1x PLUTO SecurPLATE (SUPM A)	SecurPlate02A	AVB-M2A	£269	£278	£295	£313
		SecurPlate03A	AVB-M3A	£447	£456	£473	£490
	<b>PLUTO SecurPLATE KIT</b>	SecurPlate01	AVB-M1	£269	£278	£295	£313
	Each kit includes: - 1x Standard ceiling plate (CP1) - 1x Standard column (105-SDC) - 1x PLUTO SecurPLATE (SUPM)	SecurPlate02	AVB-M2	£269	£278	£295	£313
		SecurPlate03	AVB-M3	£447	£456	£473	£490
	<b>PLUTO LITE KIT</b>	Pluto-Lite-3	AVB-P3	£313	£332	£348	£368
	Each kit includes: - 1x Standard ceiling plate (CP1) - 1x Standard column (105-SDC) - 1x PLUTO LITE cage	Pluto-Lite-4	AVB-P4	£332	£348	£368	£378
		Pluto-Lite-5	AVB-P5	£378	£393	£411	£431
		Pluto-Lite-6	AVB-P6	£431	£447	£465	£483

## PLATES & CAGES RO

	NAME	CODE	PROJECTOR SIZES (MAX)	(MAX) LOAD CAPACITY	PRICE
	<b>SecurPLATE</b> - Easily mount heavy projectors with this secure mount - Drill resistant push button locks - Heavy duty versions available	105-SUPM-1	260 x 190	20kg	£223
		105-SUPM-2	260 x 240	20kg	£223
		105-SUPM-3	310 x 285	20kg	£394
		105-SUPM-1-HD	260 x 190	40kg	£394
		105-SUPM-2-HD	260 x 240	40kg	£394
		105-SUPM-3-HD	310 x 285	40kg	£394
 	<b>SecurPLATE A</b> - Easily mount heavy projectors with this secure mount - Drill resistant push button locks - 'Slide-in' mechanism eliminates the issue of holding heavy projectors in place	105-SUPM-1A	260 x 190	20kg	£223
		105-SUPM-2A	260 x 240	20kg	£223
		105-SUPM-3A	310 x 285	20kg	£394
Bespoke projector mounts available, please ask for guidance.					
	<b>PLUTO LITE</b> - Light weight secure projector cage	PLUTO-LITE-3	355 x 310 x 90	-	£270
		PLUTO-LITE-4	355 x 310 x 115	-	£289
		PLUTO-LITE-5	385 x 365 x 140	-	£340
		PLUTO-LITE-6	435 x 410 x 165	-	£393
	<b>BESPOKE PROJECTOR CAGES</b> - Made-to-measure to your specific projector model - Available in desk and ceiling mounted configurations - Bespoke cage or SecurPlate configurations available	Desk	101-S	Bespoke plate or cage for your specific model	POA
		Ceiling	101-SS		POA

made to measure  
for your projector

# COLUMNS & ACCESSORIES RO

	NAME	MODEL	CODE	PRICE
	<b>Standard Duty Column</b>	500mm length	105-SDC050	£15
	- High quality 1.5mm thick steel poles available in a range of lengths and sizes	750mm length	105-SDC075	£30
		1000mm length	105-SDC100	£39
		1500mm length	105-SDC150	£53
		2000mm length	105-SDC200	£71
		3000mm length	105-SDC300	£106
	<b>Heavy Duty Column</b>	500mm length	105-HDC050	£31
	- High quality 3mm thick steel poles available in a range of lengths and sizes	750mm length	105-HDC075	£43
		1000mm length	105-HDC100	£55
		1500mm length	105-HDC150	£85
		2000mm length	105-HDC200	£114
		3000mm length	105-HDC300	£171
	<b>Standard Column Coupler</b>	Non-lockable	105-CC	£40
	- Column couplers enable two 50mm diameter columns to be joined together	Lockable	105-CC-L	£97
	<b>Girder Clamp</b>	-	105-GC	£126
	<b>Wall Mounting Bracket</b>	Made to order	105-WMB	£201
	- Available with throws between 600mm - 1000mm			
	<b>Trim Disc</b>	-	TRIM50	£9
	- Our trim discs cover the hole made in the ceiling tiles			
	- Provides a clean neat finish			

# CEILING PLATES & MOUNTS RO

	NAME	MODEL	CODE	PRICE
	<b>Standard Ceiling Plate</b>	Standard	105-CP1	£43
	- Suitable for 50mm diameter poles - Holes at 120 x 120mm centres			
	<b>Lockable Ceiling Plate</b>	Lockable	105-CP1-L	£138
	- Suitable for 50mm diameter poles - Holes at 120 x 120mm centres			
	<b>Large Ceiling Plate</b>	Extended	105-CP2	£71
	- Holes at 240 x 240mm centres			
	<b>Ceiling Plate w/ Tilt</b>	45° vertical tilt	105-CP7-L	£108
	- Allows for 45° movement from the vertical - Movement restricted to one axis			
	<b>Ceiling Plate w/ Pivot</b>	180° pivot	105-CP6	£81
	- Plate with 180° pivot solution to suspend projectors from angled ceilings			
	<b>Adjustable Ceiling Plate</b>	Swivel / 35° tilt / 360° rotation / lockable cover	105-CP1-UPL	£151
	- Swivel assembly provides 360° rotation and 35° tilt - Supplied with lockable cover			
	<b>Close Coupled Ceiling Plate</b>	Standard (Close coupled)	105-CCCP1	£49
	- Enables the enclosure or mount to be attached directly to the ceiling - Ideal for tight spaces			
	<b>Lockable Close Coupled Ceiling Plate</b>	Lockable (Close coupled)	105-CCCP1-L	£96
	- Enables the enclosure or mount to be attached directly to the ceiling - Ideal for tight spaces			
	<b>Tube Hook</b>	Hook	105-TM05	£64
	- Tube mount for use with 50mm diameter columns and bars - Other sizes available to order			
	<b>Tube Mount</b>	Tubing	105-TC05	£146
	- Tube mount for use with 50mm diameter columns and bars - Other sizes available to order	Tubing (Lockable)	105-TC05-L	£192
	<b>Ceiling Plate - 90°</b>	Non-locking	105-CP90	£81
	- Allows column to be secured to the side of a ceiling beam or support structure			
	<b>Twin Ceiling Plate</b>	Twin	105-CP1-TWIN	£107
	- Ideal for back-to-back mounting - Supports heavy duty projectors and screens			

# Colours & Finishes

Here at TOP-TEC, we offer a range of standard colours and worktop finishes for all of our products at no additional cost, as well as a wide variety of non-standard options on request.

Our in-house powder coating process enables us to match any requirement you may have when it comes to colour.

Offering this service in-house enables us to be extremely flexible when taking into account predetermined colour schemes, company brand colours, and guidelines set by architects and interior designers.



Please let us know what your requirements are and we will work closely with you to achieve your desired outcome.



# COLOURS & FINISHES

Customised colours, finishes and worktop materials to match specific interior design or technical requirements can also be supplied.

TOP-TEC products are available in a range of standard colours and finishes at no additional cost. If your colour is not shown please ask, we may still be able to provide it without additional cost.

## Standard metal paint colours:



White (WE)  
RAL9016



Light Grey (LG)  
RAL7035



Dark Grey (GY)  
Dalen Custom Colour



Silver (SR)  
Dalen Custom Colour



Black (BK)  
Dalen Custom Colour

## Non-standard metal paint colours (POA):



Red (RD)  
RAL3020



Green (GN57)  
RAL6005



Blue (BE)  
RAL5013



Two-tone colour finish  
+£108 per unit  
Available on Explorer & Rubi

# WORKTOPS & EDGE BANDING



## Worktop Options - AV Integrated Furniture

Worktops are available in seven standard colours and finishes.

A wide range of other colours and materials can be supplied to match your interior and corporate design at extra cost. Please contact us to discuss your requirements.

- » Worktops are supplied with a thickness of between 25mm and 40mm.
- » WARWICK NEPTUNE and Media Cabinets are supplied with a melamine faced MDF 18mm worktop with a lacquered edge.

## Edge Banding Options - AV Integrated Furniture

Worktops are supplied with durable edge banding in one of seven styles. We can also match other edge band finishes but we recommend standard edge banding as a more durable finish.

Choose between:



Square edge profile  
Included/Standard

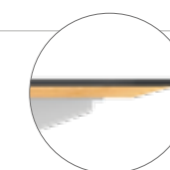

'Shark-nose' edge profile  
POA

## Group 1 - MFC: Included/Standard



Maple (M)\*  
Egger H1521



Oak (O)  
Kronospan D8925



Beech (B)\*  
Egger H1511



White (WE)\*  
Egger W980



Light Grey (LG)\*  
Egger U708



Dark Grey (DG)  
Egger U960



Black (BK)\*  
Kronospan U190

## Group 2 - Laminate: 0-1300mm worktop £40 1300-2300mm worktop £66 2300-3500mm worktop £92



Walnut (E14)\*  
Egger H3704

Shown in 'Group 1' above

- » Maple (M)\*
- » Oak (O)
- » Beech (B)\*
- » White (WE)\*
- » Light Grey (LG)\*
- » Dark Grey (DG)
- » Black (BK)\*

## Group 3 - Laminate: 0-1300mm worktop £66 1300-2300mm worktop £92 2300-3500mm worktop £119



Charcoal (F26)  
Formica F4385



Red (E30)\*  
Egger U323



Yellow (F23)  
Formica F1485



Green  
Kronospan U9561



Blue (E12)\*  
Egger U525

## \*Antibacterial Worktops

Egger worktops are tested according to the internationally recognised ISO 22196:2011, this standard measures the reduction in bacteria over a 24 hour period.

Please note: Edge banding is not antibacterial.

## Group 4 - Additional worktop & edge banding styles: POA



Real wood veneer



High gloss finishes  
on selected products



Customise your worktop  
& edge-banding colours





Compact laminates



TOP-TEC manufactures a range of secure, AV integrated and collaborative furniture solutions to the education sector.

We provide an end-to-end service from consultation, room planning right through to design, build and installation.

 is a brand of 

T: +44 (0)121 783 3838  
E: [sales@dalen.co.uk](mailto:sales@dalen.co.uk)  
W: [www.top-tec.co.uk](http://www.top-tec.co.uk)

**Dalen Limited**  
Valepits Road  
Garretts Green  
Birmingham  
B33 0TD, UK

v2501.1



Made in the UK